

RENEWAL PARTS



TYPE SB-1 AUXILIARY SWITCHES

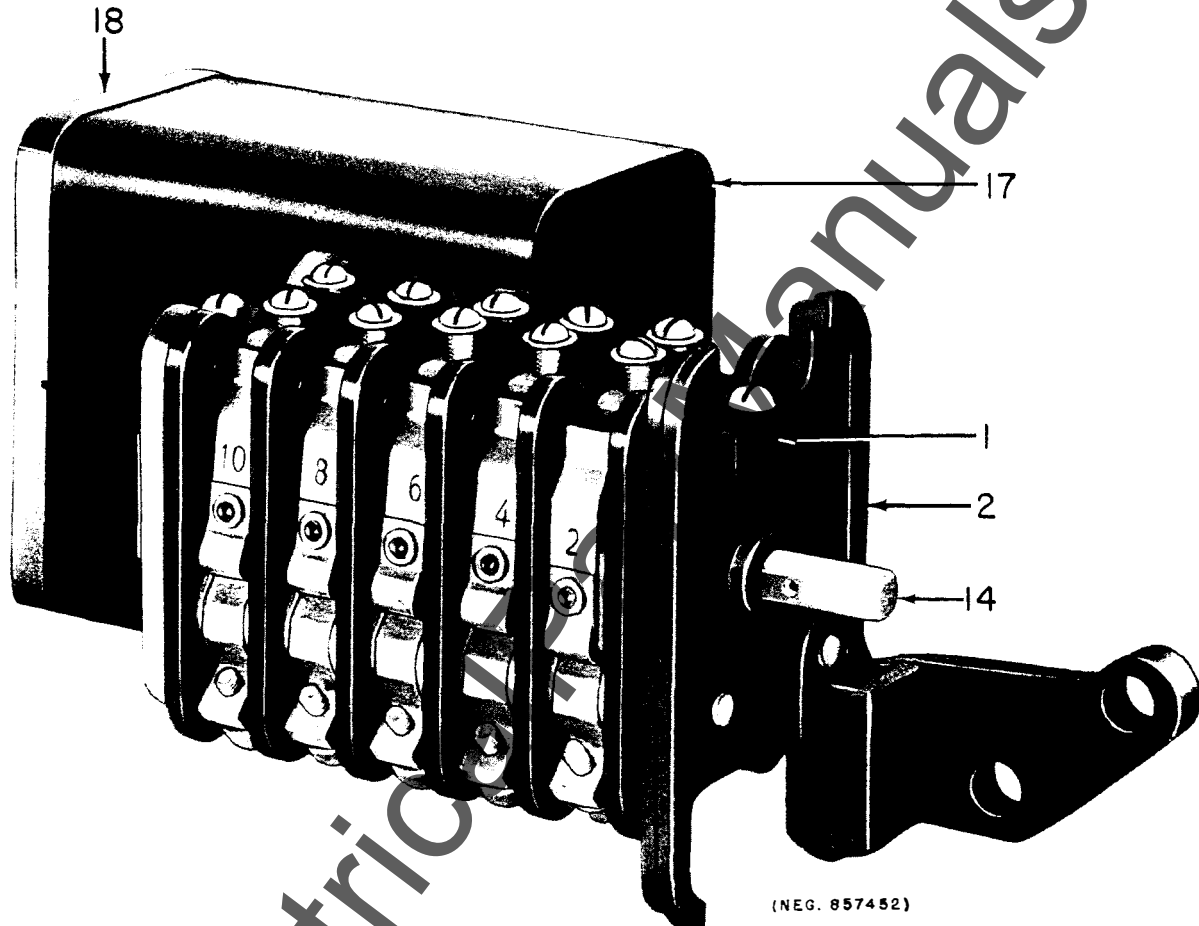

Fig. 1. Typical SB-1 auxiliary switch (cover removed)

ORDERING INSTRUCTIONS

1. Always specify the complete nameplate data of the switch.
2. Specify the quantity, catalog number (if listed), reference number (if listed), description, and this bulletin number.
3. Standard hardware, such as screws, bolts, nuts, washers, etc., is not listed in this bulletin. Such items should be purchased locally.
4. For prices, refer to the nearest office of the General Electric Company.

When ordering renewal parts, give quantity, catalog number, description of each item required, and complete nameplate reading.

GENERAL  ELECTRIC

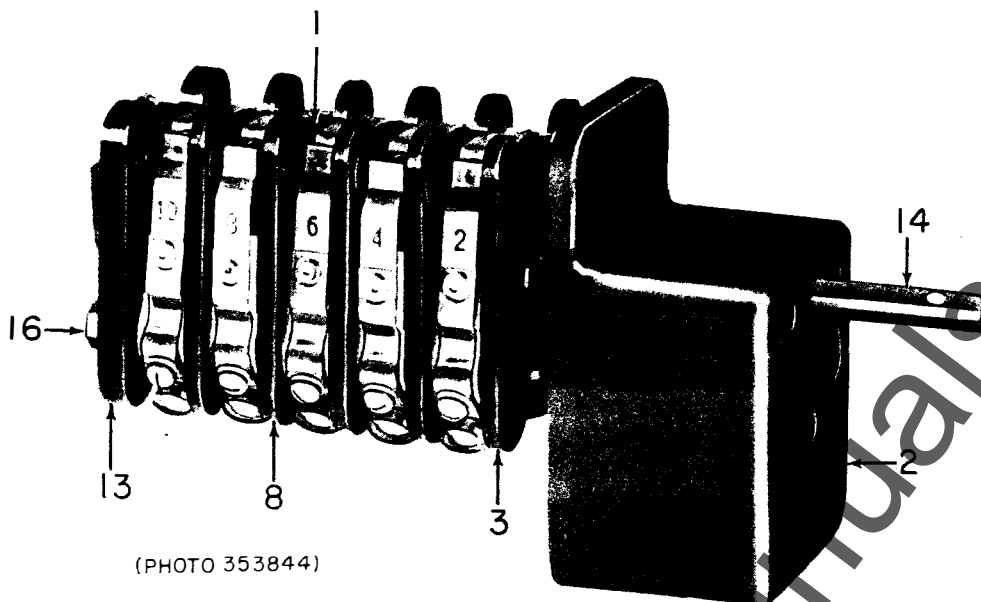

(PHOTO 353844)

Fig. 2. Typical SB-1 auxiliary switch (cover not shown)

Ref. No.	Catalog Number	Description
*1	‡	Fixed contacts and support assembly
2	‡	Base or front support
3	‡	Front barrier
*4	6009705	Torsion spring
5	§6049159	Adjustable cam
6	§6049158	Cam bushing
7A	6015928G4	Barrier and moving contacts assembly
7B	6015928G5	Barrier and moving contacts assembly
7C	6015928G6	Barrier and moving contacts assembly
8	276B518P1	Barrier
*9	6305079G1	Moving contact and flexible shunt
*10	6305079G3	Moving contact and flexible shunt
11	6047841	Washer-head connection screw
13	‡	Rear support
14	‡	Shaft
16	‡	Tie bolt
17	‡	Side cover
18	‡	End cover
†19	6047039	Screw for end cover

* Recommended for normal maintenance

† Not shown

‡ Order by description and give complete catalog number of auxiliary switch.

§ Catalog numbers listed apply only to adjustable cam and bushing shown in Fig. 7. For cut cams as shown in Fig. 8, give complete catalog number of switch, location of cam, and number molded on cam.

WWW.ELECTRICALPARTS.com

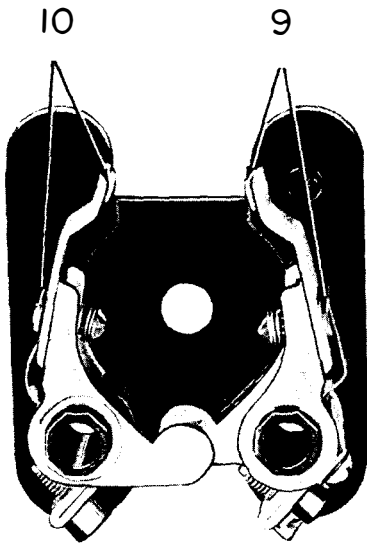

Cat. No. 6015928G6

Fig. 3. Barrier and contact assembly, connection screws entering from right (Ref. No. 7C)

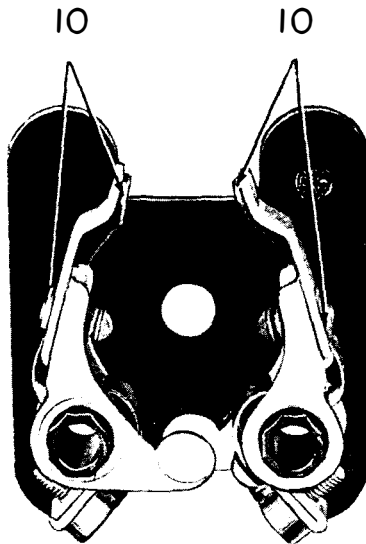

(PHOTO 8002969)

Cat. No. 6015928G5

Fig. 4. Barrier and contact assembly, connection screws entering from left and right (Ref. No. 7B)

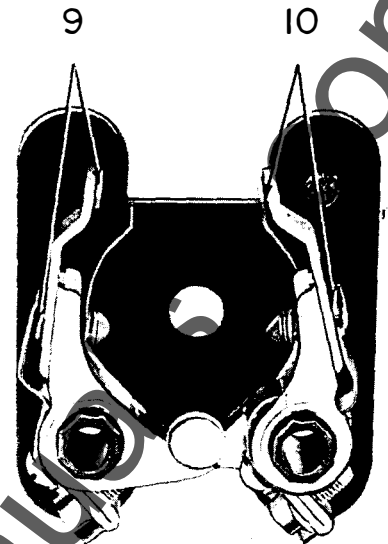

Cat. No. 6015928G4

Fig. 5. Barrier and contact assembly, connection screws entering from left (Ref. No. 7A)



(PHOTO 8001177)

Fig. 6. Torsion spring (Ref. No. 4)

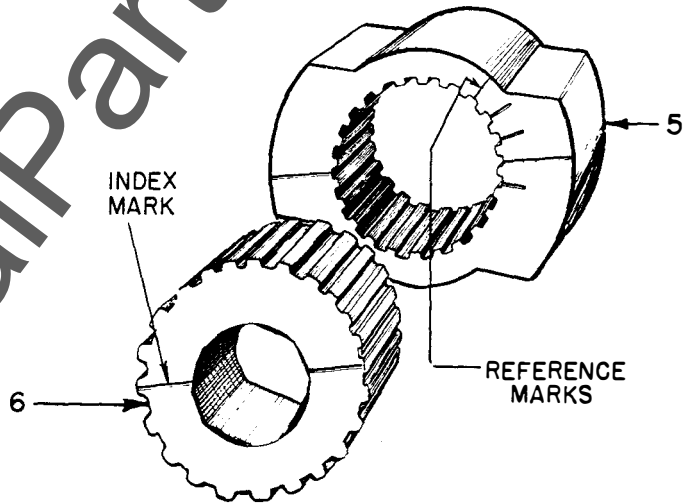

(PHOTO 1125252)

Fig. 7. Adjustable cam and cam bushing

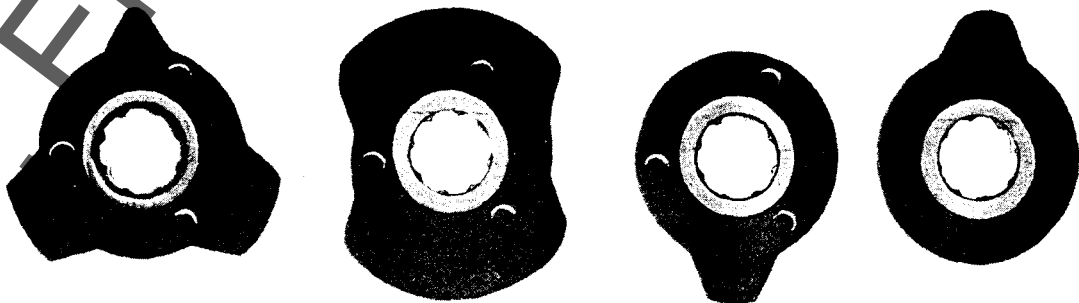

(PHOTO 8002971)

Fig. 8. Typical cut cams (Ref. No. 5)

WHEN YOU NEED SERVICE

IF YOU NEED TO REPAIR, recondition, or rebuild any electric apparatus, a G-E service shop near you is available day and night, seven days a week, for work in the shops or on your premises. Latest factory methods and genuine G-E renewal parts are used to maintain the original performance of your G-E equipment. For full information about these services, contact the nearest service shop or sales office listed below:

APPARATUS SERVICE SHOPS

Allentown, Pa. 672-676 E. Highland St.
 Appleton, Wisc. Midway Industrial Area,
 County Trunk, "P"
 Atlanta—Chamblee, Ga. 4639 Peachtree
 Indus. Blvd.
 Baltimore 30, Md. 920 E. Fort Ave.
 Boston—Medford 55, Mass. Mystic Valley Pkwy.
 Buffalo 11, N. Y. 318 Urban St.
 Charleston 28, W. Va. 306 MacCorkle Ave., S.E.
 Charlotte, N. C. 2328 Thrift Road
 Chicago 32, Ill. 4360 W. 47th St.
 Cincinnati 2, Ohio 444 W. Third St.
 Cleveland 4, Ohio 4966 Woodland Ave.
 Columbus 23, Ohio 2128 Eakin Rd.
 Corpus Christi, Texas 115 Busse St.
 Dallas 19, Texas 3202 Manor Way
 Davenport—Bettendorf, Ia. 1039 State St.
 Decatur, Ill. 2225 E. Logan St.
 Denver 5, Colo. 3353 Larimer St.
 Detroit 2, Mich. 5950 Third Ave.
 Houston 20, Texas. 5534 Harvey Wilson Drive
 Indianapolis 22, Ind. 1740 W. Vermont St.
 Johnstown, Pa. 841 Oak St.
 Kansas City 8, Mo. 819 E. 19th St.
 Los Angeles 1, Calif. 6900 Stanford Ave.
 Louisville, Ky. 2014 New Main St.
 Midland, Tex. 3404 Bankhead Hwy.
 Milwaukee 3, Wisc. 940 W. St. Paul Ave.
 Minneapolis 12, Minn. 2025 49th Ave., N.
 New Orleans, La. 2815 N. Robertson St.
 New York 14, N. Y. 416 W. 13th St.
 Oakland, Calif. 1525 Peralta St.
 Philadelphia 24, Pa. 1040 E. Erie Ave.
 Pittsburgh 6, Pa. 6519 Penn Ave.
 Portland 10, Oregon. 2727 N.W. 29th Ave.
 Richmond 24, Va. 1403 Ingram Ave.
 Roanoke, Va. 115 Albermarle St.
 Sacramento, Calif. 99 N. 17th St.
 St. Louis 10, Mo. 1115 East Road
 Salt Lake City 4, Utah. 301 S. Seventh West St.
 San Francisco 3, Calif. 1098 Harrison St.
 Seattle 4, Wash. 3422 First Ave., S.
 Southington, Conn. 53 Railroad Ave.
 Spokane 3, Wash. S. 155 Sherman St.
 Toledo 4, Ohio. 1 So. St. Clair St.
 Wheeling, W. Va. 2050 National Rd.
 York, Pa. 54 N. Harrison St.
 Youngstown 5, Ohio 272 E. Indianola Ave.

APPARATUS SALES OFFICES

Abilene, Texas. 442 Cedar St.
 Akron 8, Ohio 335 S. Main St.
 Albany 7, N. Y. 90 State St.
 Albuquerque, N. Mex. 323 Third St., S.W.
 Alexandria, La. 720 Murray St.
 Allentown, Pa. 1132 Hamilton St.
 Amarillo, Texas. Amarillo Bldg.
 Appleton, Wisc. 531 W. College Ave.
 Atlanta 3, Ga. 1860 Peachtree Rd., N.W.
 Augusta, Ga. Masonic Bldg.
 Augusta, Me. 152 State St.
 Baltimore 1, Md. 111 Park Ave.
 Bangor, Maine 77 Central St.
 Baton Rouge 6, La. 3170 Florida Blvd.
 Battle Creek, Mich. 25 W. Michigan Ave.
 Beaumont, Texas. 1385 Calder Ave.
 Billings, Mont. Rm. 816, 303 No. Broadway
 Binghamton, N. Y. 19 Chenango St.
 Birmingham 3, Ala. 1804 Seventh Ave., N.

Bismarck, N. Dak. 418 Rosser Ave.
 Bluefield, W. Va. 704 Bland St.
 Appalachian Bldg.
 Boise, Idaho. 1524 Idaho St.
 Boston 1, Mass. 140 Federal St.
 Buffalo 3, N. Y. 535 Washington St.
 Butte, Mont. P.O. Box 836, 103 N. Wyoming St.
 Canton 2, Ohio 700 Tuscarawas St., W.
 Cedar Rapids, Iowa 210 Second St., S.E.
 Charleston 28, W. Va. 306 MacCorkle Ave., S.E.
 Charlotte 1, N. C. 112 S. Tryon St.
 Chattanooga 2, Tenn. 832 Georgia Ave.
 Chicago 80, Ill. P.O. Box 5970A, 840 S. Canal St.
 Cincinnati 2, Ohio 215 W. Third St.
 Cleveland 4, Ohio 4966 Woodland Ave.
 Columbia 1, S.C. P.O. Box 1434, 1420 Lady St.
 Columbus 15, Ohio 40 S. Third St.
 Corpus Christi, Texas. 205 N. Chaparral
 Dallas 2, Texas 1801 N. Lamar St.
 Davenport—Bettendorf, Ia. 1039 State St.
 Dayton 2, Ohio 11 W. Monument Bldg.
 Dayton 9, Ohio. Avia. & Def.,
 2600 Far Hills Ave.
 Denver 2, Colo. 650 Seventeenth St.
 Des Moines 9, Iowa 505 W. Fifth Ave.
 Detroit 2, Mich. 700 Antoinette St.
 Duluth 2, Minn. 14 W. Superior St.
 Elmira, N. Y. Main and Woodlawn Aves.
 El Paso, Texas 215 No. Stanton
 Erie, Pa. 1001 State St.
 Eugene, Ore. 610 High St.
 Evansville 19, Ind. 123 N.W. Fourth St.
 Fairmont, W. Va. 310 Jacobs Bldg.,
 P.O. Box 1626
 Fergus Falls, Minn. 108 N. Court Ave. P.O. Box 197
 Flint 3, Mich. 653 S. Saginaw St.
 Fort Wayne 6, Ind. 3606 So. Calhoun St.
 Fort Worth 2, Tex. 408 W. Seventh St.
 Fort Worth, Tex. Avia. & Def.,
 6200 Camp Bowie Blvd.
 Fresno 1, Calif. 407 Patterson Bldg.
 Tulare and Fulton St.
 Grand Rapids 2, Mich. 425 Cherry St., SE
 Greensboro, N. C. 301 S. Elm St.
 Greenville, S. C. 108 W. Washington St.
 Gulfport, Miss. 207 Jo-Fran Bldg.
 Hagerstown, Md. Professional Arts Bldg.
 Hartford 5, Conn. 764 Asylum Ave.
 Houston 1, Texas. 1312 Live Oak St.
 Indianapolis 4, Ind. 110 N. Illinois St.
 Jackson, Mich. 120 W. Michigan Ave.
 Jackson 1, Miss. 203 W. Capitol St.
 Jacksonville 2, Fla. 700 E. Union St.
 Jamestown, N. Y. P.O. Box 548, 2 Second St.
 Johnstown, Pa. 841 Oak St.
 Joplin, Mo. P.O. Box 948, 220 1/2 W. Fourth St.
 Kalamazoo 3, Mich. 112 Parkway Ave.
 Kansas City 6, Mo. 106 W. Fourteenth St.
 Knoxville 08, Tenn. 602 S. Gay St.
 Lake Charles, La. 422 Seventh St.
 Lansing 8, Mich. 306 Michigan National Tower
 Lexington, Ky. First National Bank Bldg.
 Lincoln 8, Nebr. Sharpe Bldg., 206 S. 13th St.
 Little Rock, Ark. 103 W. Capitol Ave.
 Los Angeles 54, Calif. 212 N. Vignes St.
 Louisville 2, Ky. 455 S. Fourth St.
 Lubbock, Texas. 3202 Avenue "A"
 Macon, Ga. 682 Cherry St.
 Madison 3, Wisc. 16 N. Carroll St.
 Manchester, N. H. 875 Elm St.

Medford, Ore., P.O. Box 1349, 205 W. Main St.
 Memphis 3, Tenn. 8 N. Third St.
 Miami 32, Fla. 25 S.E. Second Ave.
 Midwest City, Okla. Avia. & Def.,
 207 Post Off. Bldg.
 Milwaukee 3, Wisc. 940 W. St. Paul Ave.
 Minneapolis 3, Minn. 12 S. Sixth St.
 Mobile 13, Ala. 54 St. Joseph St.
 Nashville 3, Tenn. 234 Third Ave., N.
 Newark 2, N. J. 744 Broad St.
 New Haven 6, Conn. 129 Church St.
 New Orleans 12, La. 837 Gravier St.
 New York 22, N. Y. 570 Lexington Ave.
 New York Avia. & Def., Fed. Bldg.,
 N. Y. International Airport, Jamaica 30, N. Y.
 Niagara Falls, N. Y. 253 Second St.
 Norfolk 10, Va. 229 W. Bute St.
 Oakland 12, Calif. 409 Thirteenth St.
 Oklahoma City 2, Okla. 119 N. Robinson St.
 Omaha 2, Nebr. 409 S. Seventeenth St.
 Pasco, Wash. 824 W. Lewis St.
 Peoria 2, Ill. 309 Jefferson Bldg.
 Philadelphia 2, Pa. 1405 Locust St.
 Phoenix, Ariz. P.O. Box 4037, 303 Luhrs Tower
 Pittsburgh 22, Pa. The Oliver Bldg., Mellon Sq.
 Portland 7, Ore. 920 S.W. Sixth Ave.
 Providence 3, R. I. Industrial Trust Bldg.
 Raleigh, N. C. 336 Fayetteville St.
 Reading, Pa. 31 N. Sixth St.
 Richmond 17, Va. 700 E. Franklin St.
 Riverside, Calif. 3570 Ninth St.
 Roanoke 16, Va. 920 S. Jefferson St.
 Rochester 4, N. Y. 89 E. Ave.
 Rockford, Ill. 110 S. First St.
 Rutland, Vt. 38 1/2 Center St.
 Sacramento 14, Calif. 626 Forum Bldg.
 Saginaw, Mich. Second National Bank Bldg.
 St. Louis 1, Mo. 818 Olive St.
 Salt Lake City 9, Utah. 200 S. Main St.
 San Antonio 5, Texas. 434 So. Main Ave.
 San Diego 1, Calif. 1240 Seventh Ave.
 San Francisco 6, Calif. 235 Montgomery St.
 San Jose 10, Calif. 460 Park Ave.
 Savannah, Ga. 4 E. Bryan St.
 Seattle 4, Wash. 710 Second Ave.
 Seattle 8, Wash. Avia. & Def., 220 Dawson St.
 Shreveport, La. 910 Shelby Bldg.
 Sioux City 13, Iowa. 572 Orpheum Electric Bldg.
 South Bend 1, Ind. 112 W. Jefferson Blvd.
 Spokane 4, Wash. S. 162 Post St.
 Springfield, Ill. 607 E. Adams St.
 Springfield 3, Mass. 1387 Main St.
 Stockton, Calif. 11 So. San Joaquin St.
 Syracuse 6, N. Y. 3532 James St.
 Tacoma 1, Wash. 1202 Washington Bldg.
 Tampa 6, Fla. 1206 North A St.
 Toledo 4, Ohio. 420 Madison Ave.
 Trenton 8, N. J. 214 E. Hanover St.
 Tucson, Ariz. P.O. Box 710, 650 N. Sixth Ave.
 Tulsa 3, Okla. 320 S. Boston Ave.
 Utica 2, N. Y. 258 Genesee St.
 Washington 5, D. C. 777-14th St., N.W.
 Waterloo, Iowa 206 W. 4th St.
 Wenatchee, Wash. 328 N. Wenatchee Ave.
 Wheeling, W. Va. 40 Fourteenth St.
 Wichita 2, Kan. 200 E. First St.
 Williamston, N. C. 115 E. Main St.
 Worcester 5, Mass. 288 Grove St.
 York, Pa. 56 N. Harrison St.
 Youngstown 5, Ohio 272 E. Indianola Ave.

Hawaii: American Factors, Ltd., P. O. Box 3230, Honolulu 1 Canada: Canadian General Electric Company, Ltd., Toronto
 Handbook Reference 7153

LOW VOLTAGE SWITCHGEAR DEPARTMENT, GENERAL ELECTRIC COMPANY, PHILADELPHIA, PA.