

IL 33-856-2
August 1992

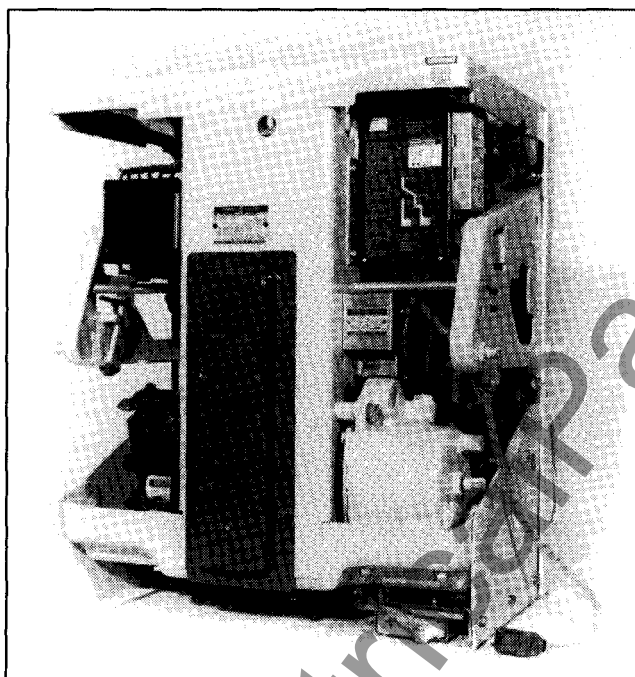

Westinghouse Digitrip Retrofit System for



**G.E. AK-2A-50
AK-2-50**

Westinghouse Electric Corp.
Specialty Products & Services Department
Commercial Operations Division
Distribution & Control Business Unit
Five Parkway Center
Pittsburgh, PA 15220

SAFETY PRECAUTIONS WARNING

Power Circuit Breakers are equipped with high speed, high energy operating mechanisms. The breakers and their enclosures are designed with several built-in interlocks and safety features intended to provide safe and proper operating sequences. To provide maximum protection for personnel associated with the installation, operation, and maintenance of these breakers, the following practices must be followed. Failure to follow these practices may result in death, personal injury or property damage.

- Only qualified persons, as defined in the National Electric Code, who are familiar with the installation and maintenance of power circuit breakers and their associated switchgear assemblies should perform any work associated with these breakers.
- Completely read and understand all instructions before attempting any installation, operation, maintenance, or modification of these breakers.
- Always turn off and lock out the power source feeding the breaker prior to attempting any installation, maintenance, or modification of the breaker. Do not use the circuit breaker as the sole means for isolating a high voltage circuit. Follow all lockout and tagging rules of the National Electric Code and all other applicable codes, regulations, and work rules.
- Do not work on a closed breaker or a breaker with the closing springs charged. Trip (open) the breaker and be sure the stored energy springs are discharged before performing any work. The breaker may trip open or the charging springs may discharge, causing crushing or cutting injuries.
- For drawout breakers, trip (open), and then remove the breaker to a well lighted work area before beginning work.
- Do not perform any maintenance, including breaker charging, closing, tripping, or any other function which could cause significant movement of the breaker while it is on the extension rails. Doing so may cause the breaker to slip from the rails and fall, potentially causing severe personal injury to those in the vicinity.
- Do not leave the breaker in an intermediate position in the switchgear cell. Always leave it in the **CONNECTED**, **TEST**, or **DISCONNECTED** position. Failure to do so could lead to improper positioning of the breaker and flashover, causing death, serious personal injury and/or property damage.
- **DO NOT DEFEAT ANY SAFETY INTERLOCK. SUCH INTERLOCKS ARE INTENDED TO PROTECT PERSONNEL AND EQUIPMENT FROM DAMAGE DUE TO FLASHOVER AND EXPOSED CONTACTS. DEFEATING AN INTERLOCK WILL LEAD TO DEATH, SEVERE PERSONAL INJURY AND/OR PROPERTY DAMAGE.**

The instructions for installation, testing, maintenance or repair herein are provided for the use of the product in general commercial applications and may not be appropriate for use in a nuclear application. Additional instructions may be available upon specific request to replace, amend or supplement these instructions to qualify them for use with the product in safety-related applications in a nuclear facility.

The information, recommendations, descriptions and safety notations in this document are based on Westinghouse's experience and judgement with respect to **RETROFITTING OF POWER BREAKERS. THIS INFORMATION SHOULD NOT BE CONSIDERED TO BE ALL INCLUSIVE OR COVERING ALL CONTINGENCIES.** If further information is required, the Westinghouse Electric Corporation should be consulted.

THERE ARE NO UNDERSTANDINGS, AGREEMENTS, REPRESENTATIONS OR WARRANTIES, EXPRESS OR IMPLIED, INCLUDING WARRANTIES OF MERCHANTABILITY OR FITNESS FOR A PARTICULAR PURPOSE, OTHER THAN THOSE SPECIFICALLY SET OUT IN ANY EXISTING CONTRACT BETWEEN THE PARTIES. ANY SUCH CONTRACT STATES THE ENTIRE OBLIGATION OR SELLER. THE CONTENTS OF THIS DOCUMENT SHALL NOT BECOME PART OF OR MODIFY ANY PRIOR OR EXISTING AGREEMENT, COMMITMENT OR RELATIONSHIP. In no event will Westinghouse be responsible to the user in contract, in tort (including negligence), strict liability or otherwise for any special, indirect, incidental or consequential damage or loss whatsoever including but not limited to damage to or loss of use of equipment, plant or power system, cost of capital, loss of profits or revenues, cost of replacement power, additional expenses in the use of existing power facilities, or claims against the user by its customers resulting from the use of the information, recommendations, descriptions and safety notations contained herein.

Step 1: Trip the Breaker and remove it from Cell. Take the Breaker to a clean well lit work bench to perform the Retrofit.

Before attempting to perform the Retrofit, be sure to read and understand the Retrofit Application Data supplied with this kit.

Refer to the components listing at the rear of this booklet. Lay out the components and hardware according to the steps as outlined. The components and hardware will be used to complete each assembly step that follows.

Step 2:

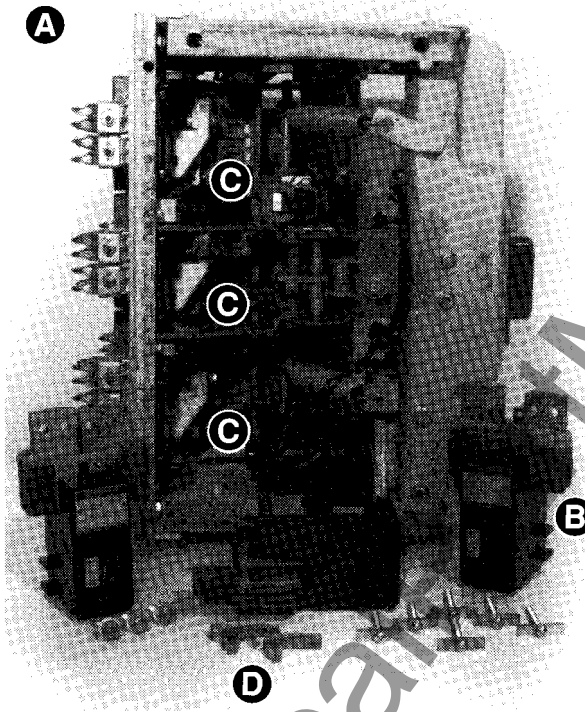

- A. Carefully lay the Breaker over on its right hand side to provide access to its underside.
- B. Remove the Electromechanical Trip Unit from each Phase.
- C. Install a Copper Adapter on each Phase with the hardware provided as shown.

Note: On RMS/R 700 and 800 Kits only. As viewed from the front, do not install the left hand bolt of each Phase. The PT Module leads will attach to it later.

- D. Remove the Electromechanical Trip Paddles from the Breaker Trip Bar.
- E. Carefully stand the Breaker back up to its original position.

Step 3:

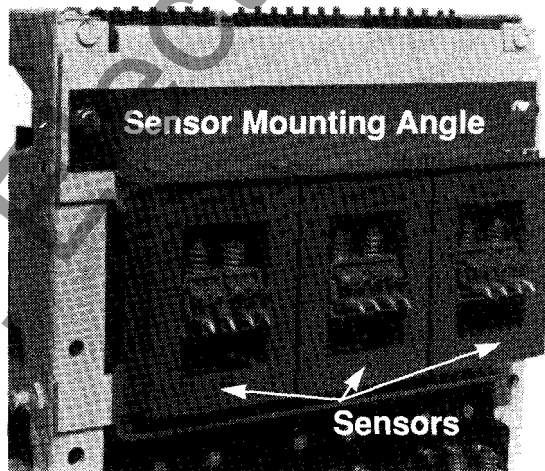

- A. Install the Sensor Mounting Angle on the top rear of the Breaker with the hardware provided as shown.
- B. Mount the Sensors to the Mounting Angle with the hardware provided as shown.

Step 4: Drilling Plan A

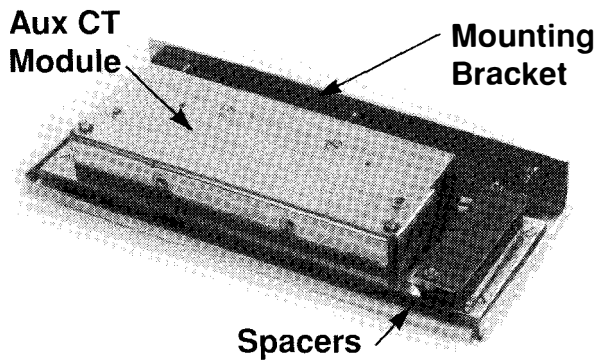
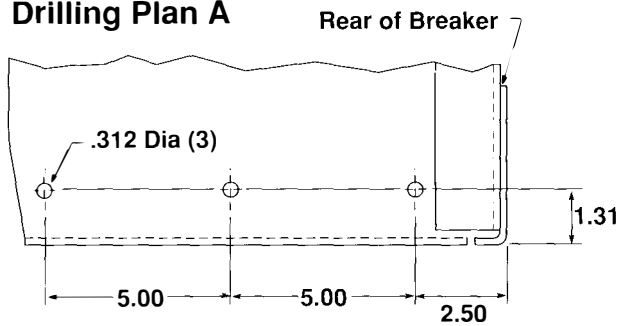

Step 5:

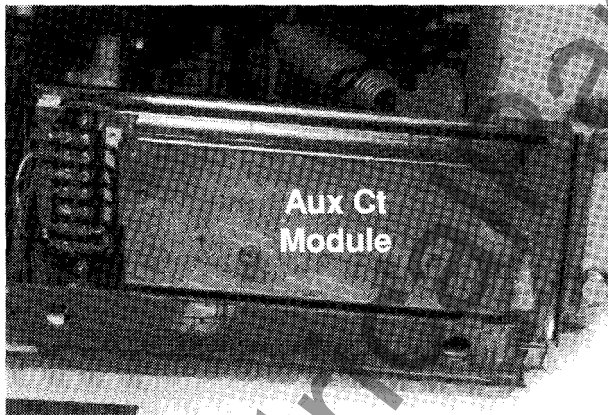

- Carefully lay the Breaker over on its left side.
- Lay out and drill the bottom right side of the Breaker per Drilling Plan "A".

Note: Cover the region below the area to be drilled to prevent drilling chips from falling into the Breaker.

- Mount the Aux. CT Module to the Mounting Bracket with three spacers at each end using the hardware provided as shown.
- Mount the Aux. CT Module Assembly on the bottom right inside of the Breaker with the hardware provided using the holes drilled in Step 4B.

- Remove the Terminal Block Cover from the 7 Point Terminal Block on the Aux. CT Module.
- Connect the Snap Spade Terminals of the Sensor Wire Harness to the correct terminals on the 7 Point Terminal Block. See the Retrofit Application Data supplied with the retrofit kit for proper connection and application.

NOTE: The long tan and green wires are for Remote Neutral Sensor on a 4W Ground Breaker. They should be removed if not required.

- Connect the Snap Spade Terminals of the Direct Trip Actuator (DTA) Wire Harness to the 7 Point Terminal Block. The wire marked + is to connect to the "OP" Terminal and the unmarked wire to the "ON" Terminal.
- Replace the Terminal Block Cover.

**Step 5
(cont.):**

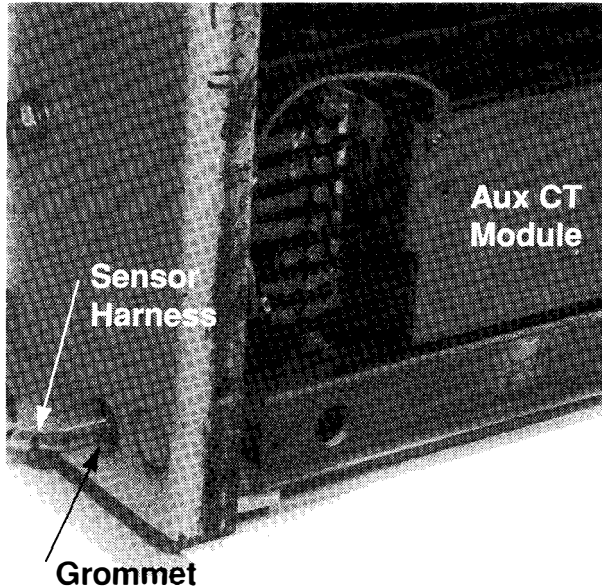

- E. Install a grommet in the bottom right hole of the Breaker Rear Frame near the Aux. CT Module.
- F. Route the Sensor Wire Harness back thru the grommet and up to the Sensors.
- G. Connect the Ring Terminals to the proper terminals of the Sensors per the Connection Diagram in the Retrofit Application Data.

Sensor Style No. 8258A33H01
X1-X3 = 1600A X1-X2 = 800A

Sensor Style No. 8258A34H01
X1-X3 = 800A X1-X2 = 400A

Sensor Style No. 8258A35H01
X1-X3 = 400A X1-X2 = 200A

- H. Use nylon wire ties to dress up wiring and keep it away from any moving parts.
- I. Carefully stand the Breaker back up to its original position.

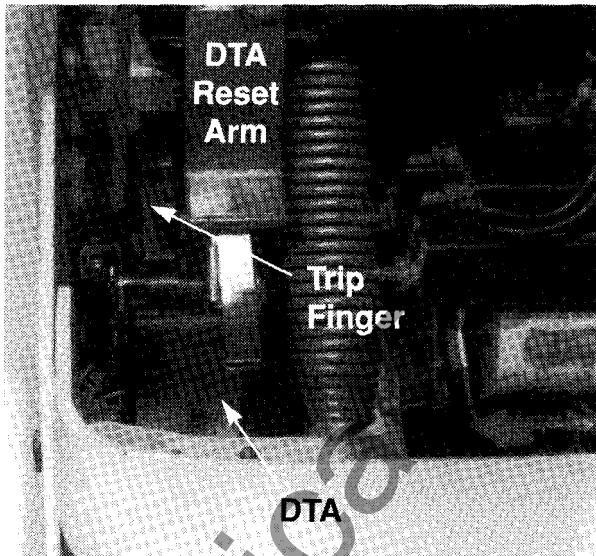

Step 6:

- A. Mount the Trip Finger on the Breaker Trip Bar as shown using the hardware provided. Do not tighten hardware yet. The Trip Finger should be free to move the Trip Bar.

- B. Position the Direct Trip Actuator (DTA) near the front of the Breaker. Bring the DTA Harness from the Aux. CT Module under the front of the breaker to the DTA. Connect the wire marked with the + to the same terminal the DTA wire marked + is connected. Connect the unmarked wire to the same terminal the DTA unmarked wire is connected.
- C. Carefully tilt the Breaker back and slide the DTA under the front of the breaker toward the left hand side. The Terminal Block should be facing the rear. Lower the Breaker back down, being careful to avoid damaging the DTA.
- D. Mount the DTA to the left hand bottom of the Breaker using the existing holes in the Breaker Frame with the hardware provided as shown.
- E. Slide the Trip Finger on the Breaker Trip Bar over so that the Trip Finger is located under the left hand side of the DTA Flange nut. Tighten the hardware securely on the Trip Finger.
- F. Remove the .375-16 X 1.50 hex bolt from the left hand side of the Breaker Cross Bar. Mount the DTA Reset to the Cross Bar with the bolt just removed. Be sure to lock the bolt head when tight with the locking clip.

Step 7:

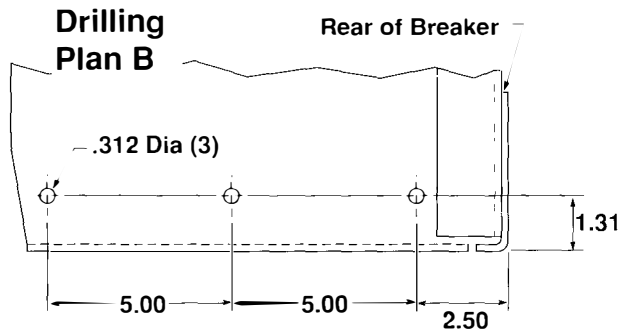

- A. Locate and drill two .312 dia. holes in the right hand side of Breaker Mechanism Housing. See Drilling Plan "B".

Note: Cover the area (both inside and outside) below to prevent the drilling chips from falling into the Breaker Mechanism.

Step 8:

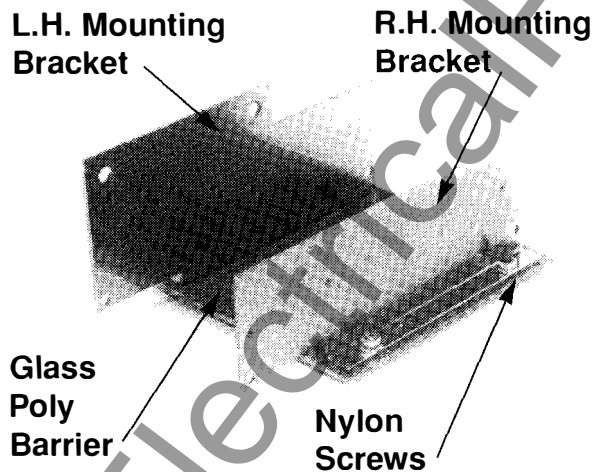

- A. Assemble the left hand (the larger Bracket with projection) and right hand Trip Unit Mounting Brackets to the Glass Poly (red) Barrier with the hardware provided as shown. The nylon screws are to be in the top holes and the steel screws are to be in the bottom holes with the screw heads on the Glass Poly Barrier side.

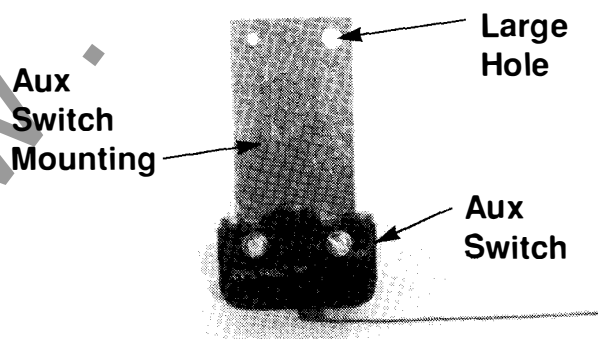

- B. *RMS/R 700 and 800 Kits only.* Assemble the Microswitch to the Mounting Bracket as shown with the hardware provided.

**Step 8
(cont.):**

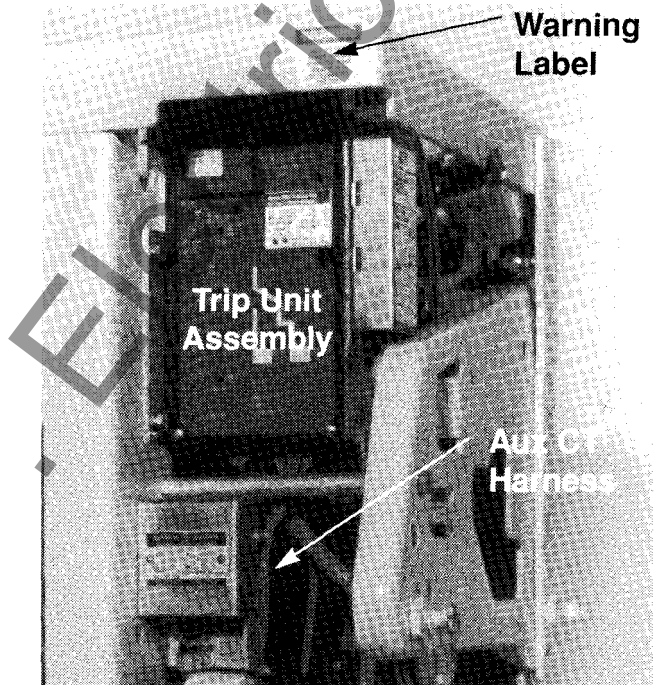
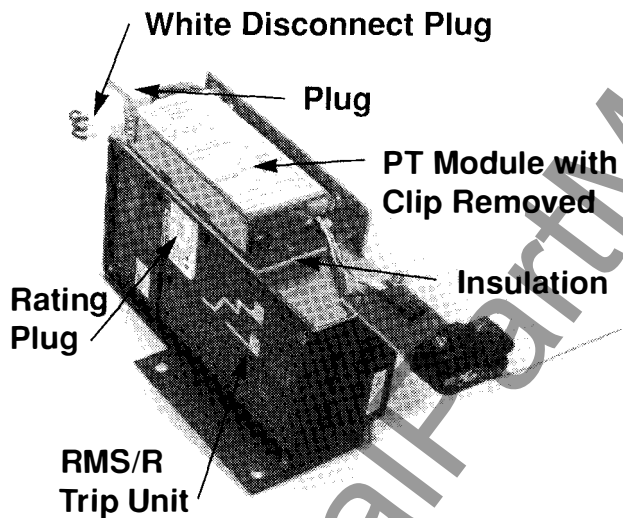
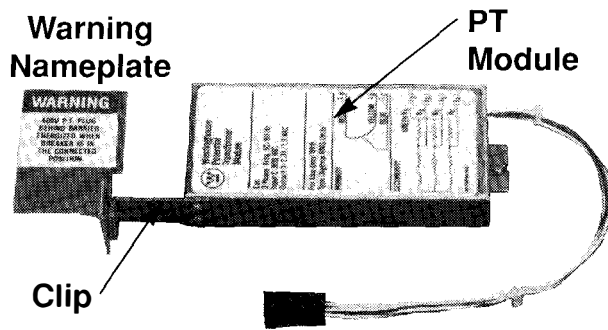

C. *RMS/R 700 and 800 Kits only.*

Remove the white Disconnect Plug from the Potential Transformer Module (PT Module). Remove the two screws that hold the Plug and Warning Nameplate to the clip. Remove the two screws that hold the clip to the PT Module Body. Rotate the plug down and mount to the PT Module Body where the clip was using the same hardware. Replace the Disconnect plug. Scrap the Warning Nameplate, Clip, and two screws.

D. Assemble the Trip Unit on the Mounting Bracket Assembly as shown using the 5-inch long screws and four brass spacers provided.

RMS/R 700 and 800 Kits only. Mount the Microswitch Assembly on right hand bottom Trip Unit as shown.

E. *RMS/R 700 and 800 Kits only.* Mount the PT Module to the right hand Trip Unit Mounting Bracket with the Glass Poly (red) Insulation Barrier between them using the hardware provided as shown.

F. Remove Trip Unit cover and install Rating Plug, replace cover.

G. Mount the Trip Unit Assembly to the Breaker Mechanism Housing using the holes drilled in Step 7A with the hardware provided as shown.

H. Mount the PT Module Warning Nameplate on the outside top right Breaker Frame in front of the PT Module.

Step 9:

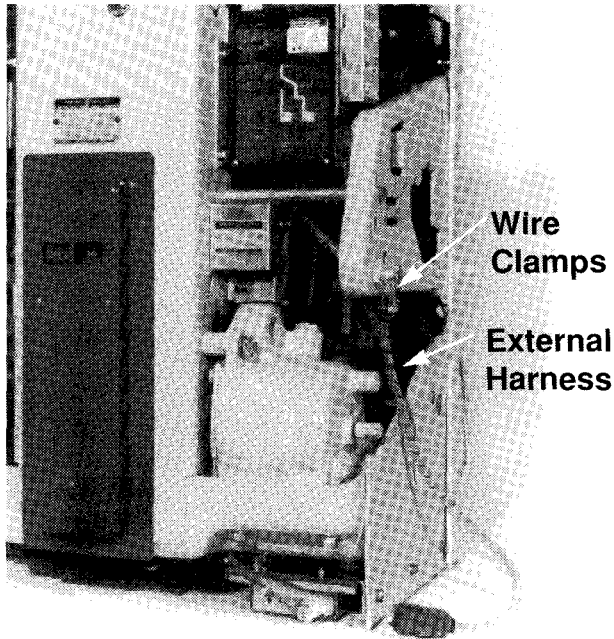

NOTE: For RMS/R 500 Basic Retrofit Kits the External Harness is the plug pictured below. It is to be plugged into the bottom of the Trip Unit.



- A. *RMS/R 700 and 800 Kits only.* Route the 3 wires from the PT Module down into the Breaker to the Copper Adapters installed in Step 2C. Cut the wire marked with red to Phase 1. Cut the wire marked with yellow to Phase 2. Cut the wire marked blue to Phase 3. Strip the wires 1/4 inch and install a .38 Ring Terminal on each. Connect each wire to the correct Copper Adapter using the bolt, washer and lockwasher left from Step 2C. Use nylon wire ties and nylon clamps with hardware provided to keep wires away from Breaker moving parts.
- B. Plug the Aux. CT Harness into the Aux. CT Module. Route the Aux. CT Harness up along the Breaker Mechanism Housing to the bottom of the Trip Unit and plug in. Use nylon wire ties to keep wires away from Breaker moving parts.
- C. Plug the External Harness in the bottom of the Trip Unit. Route the harness to the right hand inside Breaker Frame and secure with two nylon wire clamps and hardware provided.
- D. *RMS/R 700 and 800 Kits only.* Connect the plug from the PT Module to the plug on the External Harness.
- E. *RMS/R 700 and 800 Kits only.* Connect the two wires with ring terminals from the External Harness to the Microswitch. One wire on the Normally open Terminal and the other wire on the Common Terminal.

Step 10: The Cell Harness is to be mounted in the Breaker Cell. The Plug End is to be mounted on the right front side of the Cell. The Terminal Blocks can be mounted anywhere space is available in the Cell. With the Breaker in the Cell and the External Harness connected to the Breaker, they should be free to go from disconnect to the connected position, and all Retrofit Wiring should be out of the way.

Step 11: The Retrofit is now complete and ready to be tested. See the Retrofit Application Data for test procedures.

**DIGITRIP RETROFIT KIT INSTALLATION COMPONENTS
FOR AK-2A-50 BREAKERS**

STEP	DESCRIPTION	STYLE NO.	QTY.	COMMENTS	
STEP 2	COPPER CONNECTOR		3		
	0.375-16 X 1.50 LNG HEX BOLT		12		
	0.375 FLAT WASHER STL		12		
	0.375 LOCK WASHER STL		12		
STEP 3	SENSOR 400 DR	8258A35H01	3	OPTIONAL SENSOR	
	SENSOR 800 DR	8258A34H01	3	OPTIONAL SENSOR	
	SENSOR 1600 DR	8258A33H01	3		
	SENSOR MTG ANGLE	6503C68H01	1		
	0.500-13 X 1.50 LNG HEX BOLT		2		
	0.500 FLAT WASHER STL		4		
	0.500 LOCK WASHER STL		2		
	0.500-13 NUT HEX STL		2		
	0.250-20 X 0.500 LNG HEX BOLT		12		
	0.250 FLAT WASHER STL		12		
	0.250 LOCK WASHER STL		12		
	STEP 4	AUX CT MODULE	6503C59G	1	
		MOUNTING BRACKET		1	
SPACERS			6		
0.190-32 X 0.750 LNG FLAT HEAD SCREW			4		
0.190 FLAT WASHER STL			4		
0.190 LOCK WASHER STL			4		
0.190-32 NUT HEX STL			4		
0.250-20 X 0.750 LNG HEX BOLT			3		
0.250 FLAT WASHER STL			3		
0.250 LOCK WASHER STL			3		
STEP 5	SENSOR HARNESS		1		
	DTA HARNESS		1		
	GROMMET		1		
	WIRE TIES NYLON		6		
STEP 6	TRIP FINGER		1		
	DTA	8258A95G03	1		
	DTA RESET ARM		1		
	0.250-20 X 0.75 LNG CRG BOLT		1		
	0.250 FLAT WASHER STL		1		
	0.250 LOCK WASHER		1		
	0.250-20 NUT HEX STL		1		
	0.375-16 X 1 LNG HEX BOLT		2		
	0.375 FLAT WASHER		4		
	0.375 LOCK WASHER		2		
	0.375-16 NUT HEX STL		2		

**DIGITRIP RETROFIT KIT INSTALLATION COMPONENTS
FOR AK-2A-50 BREAKERS
(CONTINUED)**

STEP	DESCRIPTION	STYLE NO.	QTY.	COMMENTS
STEP 8	RMS/R TRIP UNIT	1232C97G__	1	
	RATING PLUG PR6A16A160	3D86709G06	1	
	TRIP UNIT MTG BRACKET LH		1	
	TRIP UNIT MTG BRACKET RH		1	
	BARRIER RED POLYESTER		1	
	SPACER BRASS		4	
	0.190-32 X 5.000 LNG SCREW		2	
	0.190-32 X 0.500 LNG SCREW		2	
	0.190-32 X 0.625 LNG NYLON SCREW		2	
	0.190 FLAT WASHER STL		10	
	0.190 FLAT WASHER NYLON		2	
	0.190 LOCK WASHER STL		6	
	0.190-32 NUT HEX STL		6	
	0.250-20 X 0.750 LNG HEX BOLT		2	
	0.250 FLAT WSHR STL		4	
	0.250 LOCK WASHER STL		2	
	0.250-32 NUT HEX STL		2	
	AUX SWITCH KIT	8258A95G02	1	700/800 KITS ONLY
	MICROSWITCH		1	"
	MOUNTING BRACKET		1	"
	0.138-32 X 0.375 LNG SCREW		1	"
	0.138-32 X 1.00 LNG SCREW		2	"
	0.138 FLAT WASHER STL		5	"
	0.138 LOCK WASHER STL		3	"
	0.138-32 NUT HEX STL		2	"
	PT MODULE KIT	6502C82G01	1	700/800 KITS ONLY
	PT MODULE		1	"
	PT MODULE INSULATION		1	"
	0.138-32 X 0.375 LNG SCREW		2	"
	0.138 FLAT WASHER STL		2	"
0.138 LOCK WASHER STL		2	"	
WARNING NAMEPLATE		1	"	
STEP 9	AUX CT HARNESS	6502C84G02	1	
	EXTERNAL HARNESS	6502C83G__	1	
	WIRE TIES NYLON SMALL		6	
	WIRE TIES NYLON LARGE		4	
	WIRE CLAMP NYLON		7	
	0.164-32 X 0.75 LNG SCREW		7	
	0.164 FLAT WASHER STL		14	
	0.164 LOCK WASHER STL		7	
	0.164-32 NUT HEX STL		7	
	0.375 RING TERMINAL		3	700/800 KITS ONLY
	STEP 10	CELL HARNESS	6503C57G__	1

NOTE: Due to the wide vintage of breakers and the multiple functions of the retrofit components, some excess hardware may be left when the retrofit is complete.

TYPICAL RMS/R 800 RETROFIT KIT

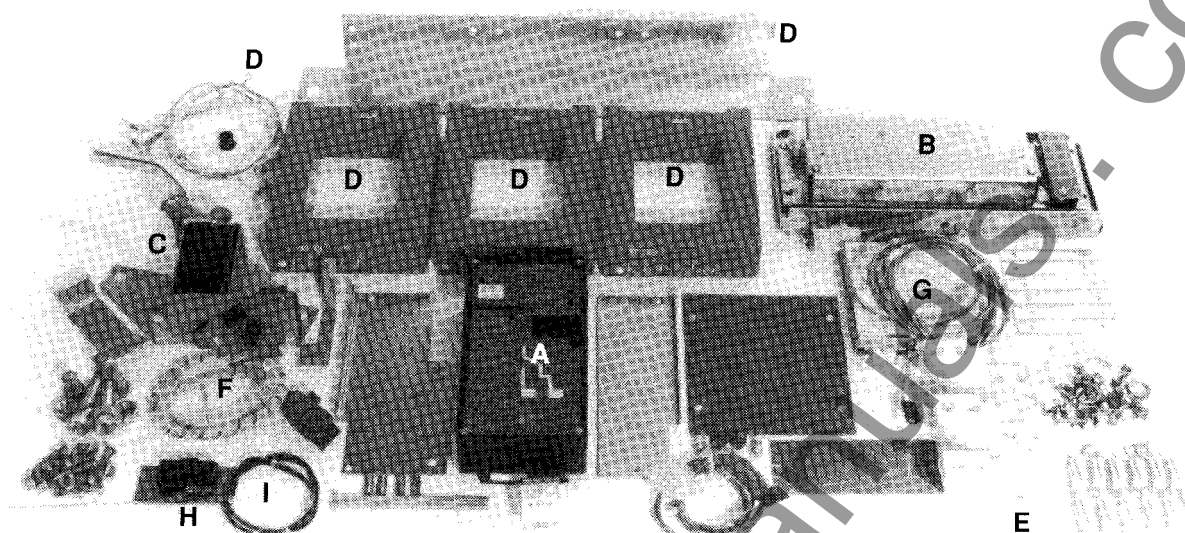

- A. Trip Unit Assembly
- B. Auxiliary CT Module and Mounting
- C. Direct Trip Actuator
- D. Sensors, Mounting and Wire Harness
- E. Copper Adapters
- F. External Wire Harness
- G. PT Module
- H. Auxiliary Switch
- I. DTA Wire Harness

Westinghouse wishes to thank you for purchasing the Digitrip Retrofit System. Digitrip Retrofit Kits are designed and manufactured in America with pride. All the components are engineered to fit the existing Circuit Breaker with little or no modifications to the existing Breaker. However due to the wide variety and vintage of Breakers in use today, an occasional problem may arise. Please contact us with any questions, comments or concerns.

Westinghouse Electric Corp.
Distribution & Control Business Unit
Five Parkway Center
Pittsburgh, PA 15220

Fax: (412) 937-6770
WIN: 227-6770
Phone: (412) 937-6426
(412) 937-6727
(412) 937-6708
(412) 937-6725