

ONLY THE 3RD CONT FROM EACH END OF ANY STA SEC CONT BLK CAN BE SPLIT (TEST & CONN)

EQUIP. SHOWN OUTSIDE OF BKR BROKEN LINE OUTLINE ON SCHEMES, IS NOT SUP. W/BKR

DIAGRAM DETAILS ARE SHOWN F.V. FOR DRAWOUT BKRS. FOR FIXED BKRS USE CORRESPONDING T. BLK POINTS INSTEAD OF DRAWOUT SECONDARY CONTACTS.

SEC CONT WIRE COLOR CODING--FOR REF ONLY

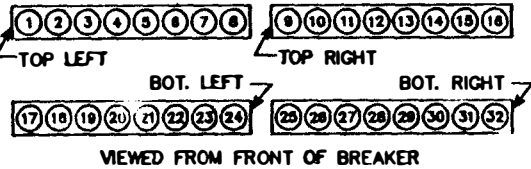

LEGEND

- AMPT = AMPLECTOR, SOL-STATE CONT
- ACTR = ACTUATOR, SOL-STATE BKR TR
- HLS = HIGH LOAD SWITCH
- LCS = LATCH CHECK SWITCH
- LO = LOCK OUT
- LS = LIMIT SW FOR CLOSING SPR
- MOT = MOTOR FOR SPR CHARGING
- OTS = OVERCURRENT TRIP SWITCH
- PB = PUSHBUTTON
- SEN = SENSOR
- SH TR = SHUNT TRIP
- SR = SPRING RELEASE
- UV = UNDERVOLTAGE
- Y = ANTI-PUMP RELAY

OPERATION OF PWR OPER. MECH STD (REFER TO FIG. 6A)

- 1 - WHEN BKR OPENS MOT IS ENERGIZED THRU LS & 'b' CONT
- 2 - MOT RUNS & CHARGES CLSPG
- 3 - WHEN CLSPG ARE FULLY CHARGED LS CONTACTS REVERSE
- 4 - CLOSING CS-C CONT ENERGIZES SR COIL THRU Y LS & 'b' CONT
- 5 - WHEN BKR CLOSES 'b' OPENS & Y COIL IS ENERG. IN SER WITH SR COIL
- 6 - Y CONT OPENS TO OPEN SR COIL CKT & PREVENT PUMPING SHOULD BKR OPEN WHILE CS-C IS HELD CLOSED. Y COIL HAS VERY LOW DROP OUT VOLTAGE.

SPECIAL (FIG. 7A)

SAME AS FOR STD ABOVE EXCEPT MOTOR RUNNING DEPENDS ONLY ON LS CONTACT

CONTENTS

L	EQUIPMENT	SH
	LEGEND	1
1	SERIES TRIP, 3P	2
2	ELEC. SPRING REL	3
3	SHUNT TRIP	3
4	ELEC. LO (MO BKR)	3
5	UNDERVOLTAGE	3
6	OC TR SW (OTS)	4
7	BLANK	5
8	PWR OPR MECH, STD	6
9	PWR OPR MECH, SPL	7
10	BLANK	8
11	AUX SW 1	9
12	AUX SW 1	10
13	AUX SW 2	11
14	AUX CT FOR GRD EL	12
15	MISC	13
16	SERIES TR AMPT II	14
17	SPECIAL	15
18	SPECIAL	16
19	OEM SPECIAL	17
20	RMS DIGITRIP	18
21	SCHEMATIC T500	19
22	SCHEMATIC T600	20
23	SCHEMATIC T700&T800	21
24	SUB NOTES	22

NOTES:

1. TABULATION ON LH SIDE OF EACH FIG. IS LOCATION CODE FOR WIRING HARNESS.
2. A NUMERAL IS ADDED TO CERTAIN FIG. NO. ON THE BKR NP TO INDICATE COIL VOLTAGE AS FOLLOWS: 1, 2, 3 & 4 = 24, 48, 125 & 250V DC RESP; 5, 6, 7 & 8 = 115, 208/230, 480 & 208V ONLY, AC RESP; 9 = ANY OTHER VOLT (32V DC, ETC.) MAN. OPR BKR WITH SHUNT TRIP & CAP DEV WILL HAVE DIAG CODE 3BC

NEXT ASSY
ENG REF 800A800
SEE SEPERATE PL
PL 508B508

1	
2	T0011789
3	T0011090
4	T0042790
5	

ALL REV. NOTES LISTED ON SHEET 22 ALL OTHER SHEETS JUST REV. NO. ONLY

ELECTRICAL COMPONENTS DIVISION
PITTSBURGH, PA 15275

Westinghouse Electric Corporation

DESIGN & P TECHNOLOGY & QUALITY DIV. TECHNICAL CENTER

DS CIRCUIT BREAKER
BREAKER INTERNAL WIRING
LEGEND

THOMAS

DRG. NO. 508B508

SCALE

FIG. NO. TQ050001

SHEET NO. 1 OF 22 SHEETS

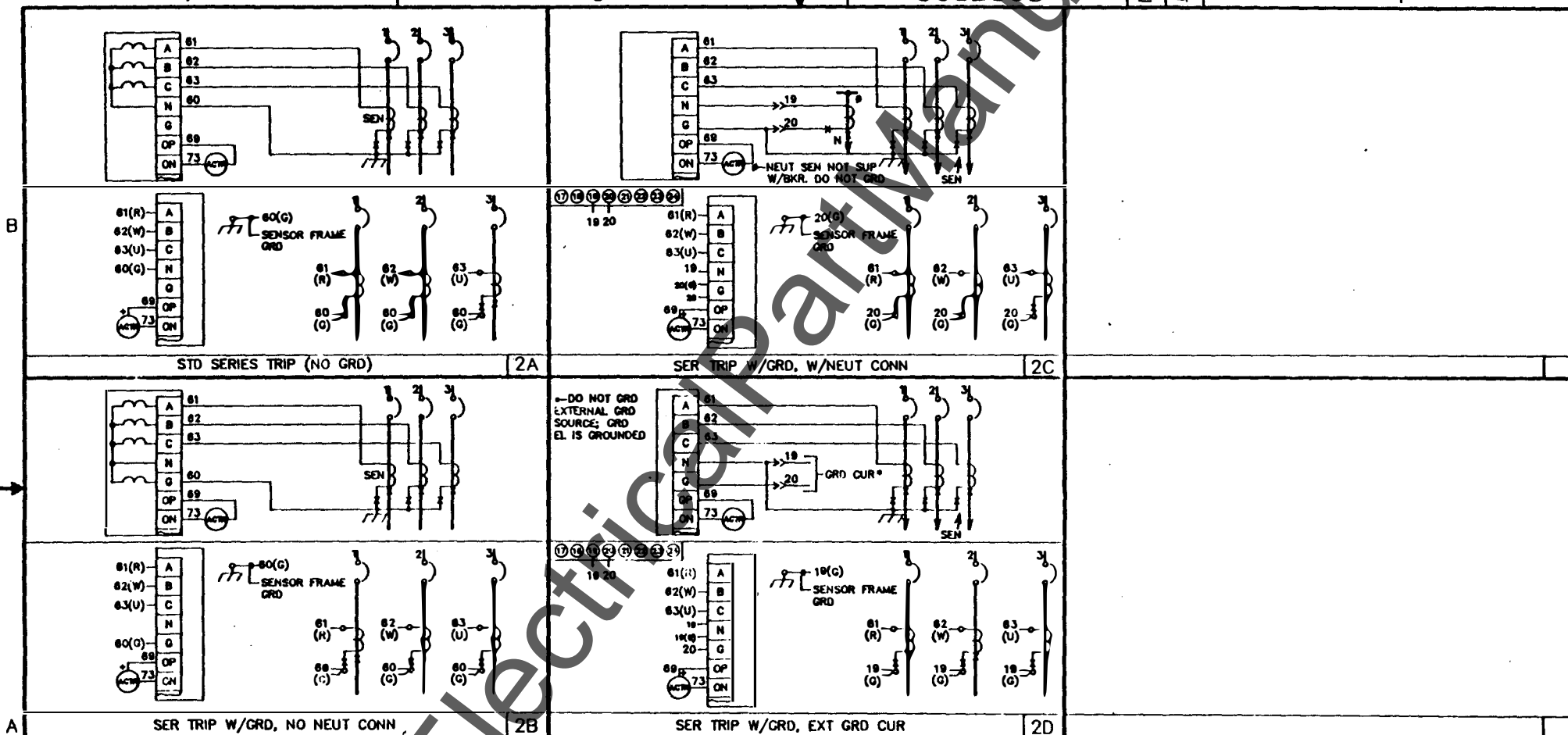

1	2	3	4	5
REVISION	TQ011789	TQ011090	TQ042790	

ALL REV. NOTES LISTED ON SHEET 22 ALL OTHER SHEETS JUST REV. NO. ONLY

ELECTRICAL COMPONENTS DIVISION
PITTSBURGH, PA 15275

Westinghouse Electric Corporation 
D & P TECHNOLOGY & QUALITY DIV. TECHNICAL CENTER

TYPE DS CIRCUIT BREAKER
SERIES TRIP, 3P DIGITRIP
AMPT. I & AMPT. II

SIZE B FILE NO. DWG. NO. 508B508
SCALE FILE NO. TQ050002 SHEET NO. 2 OF 21 SHEETS

DWG. NO. 508B508 SHEET 3 REV. 5

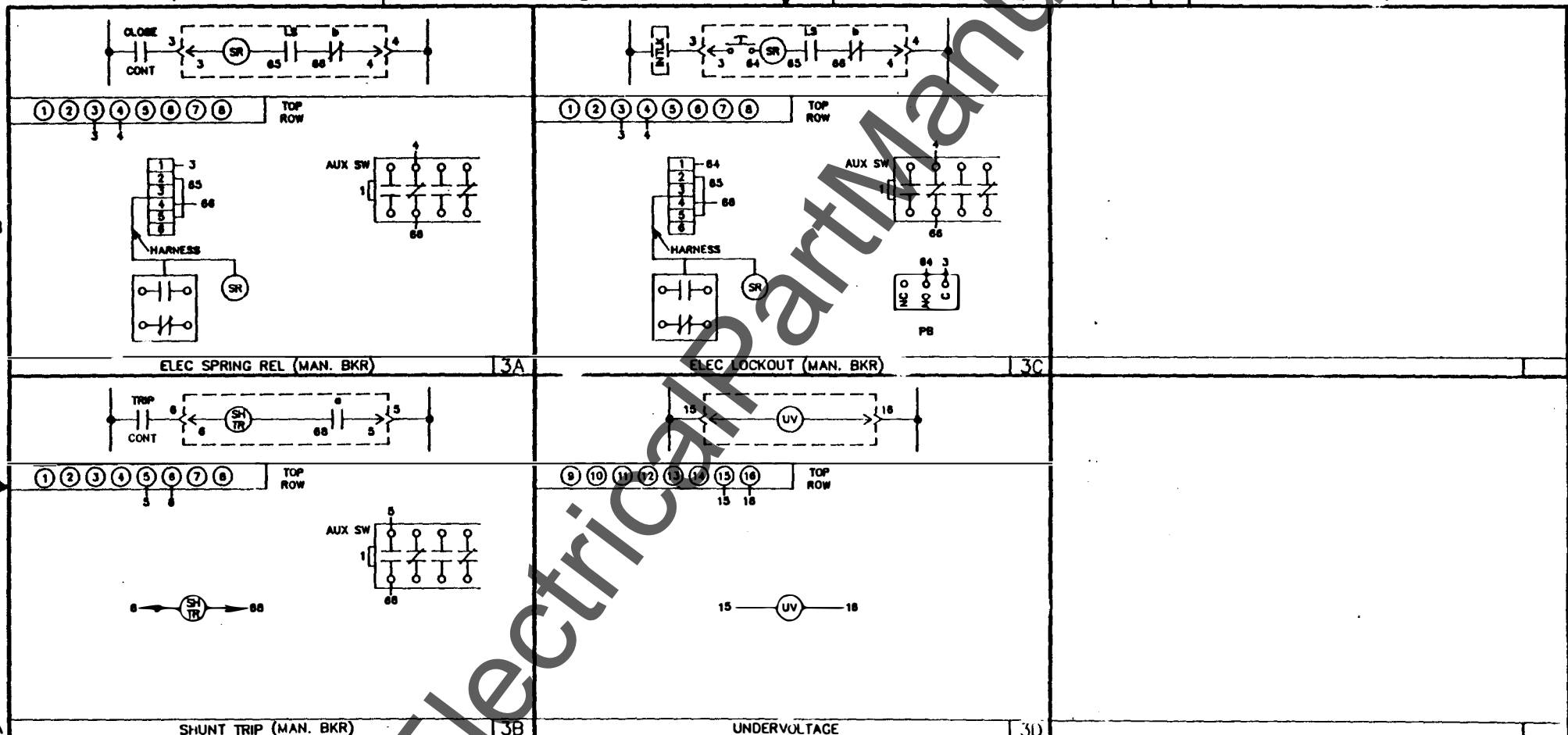

1	2	3	4	5
REVISION	T0011789	T0011090	T0042790	

ALL REV. NOTES LISTED ON SHEET 22 ALL OTHER SHEETS LIST REV. NO. ONLY

ELECTRICAL COMPONENTS DIVISION PITTSBURGH, PA 15275		Westinghouse Electric Corporation	
DATE: APR 17 1961	APPROVED: THOMAS	DESIGNED BY: THOMAS	TECHNICAL OFFICER
DS CIRCUIT BREAKER BASIC ACCESSORIES		SIZE: B	SCALE: 1" = 1"
DWG. NO. 508B508		FILE NO. TQ050003	SHEET NO. 3 OF 22 SHEETS

www.ElectricalPartManuals.com

DWG. NO. 508B508

REV. 4 5

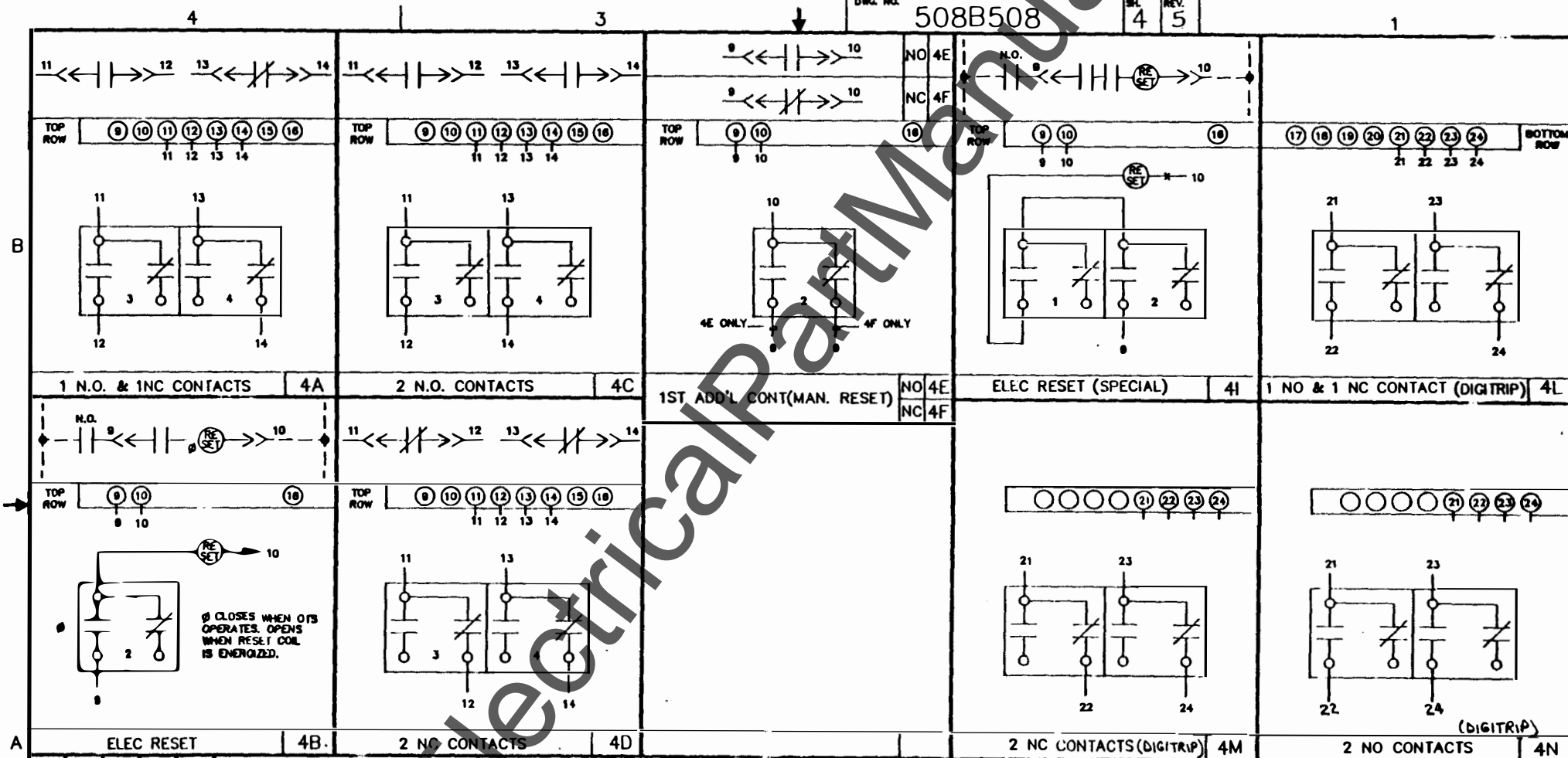

1	2	3	4	5
TO017E9	TO011090	TO042790		

REV. NOTES LISTED ON SHEET 22 ALL OTHER SHEETS LIST REV. NO. ONLY

ELECTRICAL COMPONENTS DIVISION
PITTSBURGH, PA 15275

Westinghouse Electric Corporation

D. & P. TECHNOLOGY & QUALITY DIV. TECHNICAL CENTER

DS CIRCUIT BREAKER
OVERCURRENT TRIP SWITCH (OTS)
CONTACTS CHG STATE & LATCH ONLY
WHEN AMPT TRIPS BREAKER

SIZE B FROM NO. DWG. NO. 508B508

SCALE FILE NO. T1050004 SHEET NO. 5 OF 22 SHEETS

DRWG. NO. 508B508

SPL. 5 REV. 5

BLANK

W. ElectricalPartManuals.com

1	
2	TQ011789
3	TQ011090
4	TQ042750
5	

ALL REV. NOTES LISTED ON SHEET 22 ALL OTHER SHEETS LIST REV. NO. ONLY

ELECTRICAL COMPONENTS DIVISION
PITTSBURGH, PA 15275

DFTL. AGLETR/CS
 APPD. MORGAN
 APPD. BLAKE
 THOMAS

Westinghouse Electric Corporation
 D & P TECHNOLOGY & QUALITY DIV. TECHNICAL CENTER
 TITLE DS CIRCUIT BREAKER
 SIZE B
 SCALE
 FILE NO. TQ050005
 DRWG. NO. 508B508
 SHEET NO. 2 OF 22 SHEETS

DWG. NO. 508B508

S/L 6 REV. 5

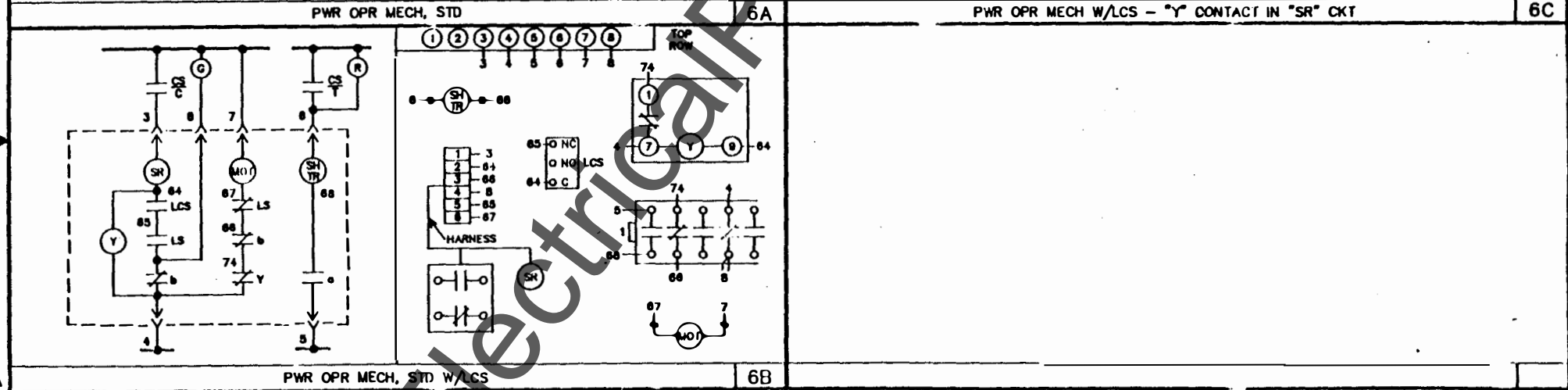
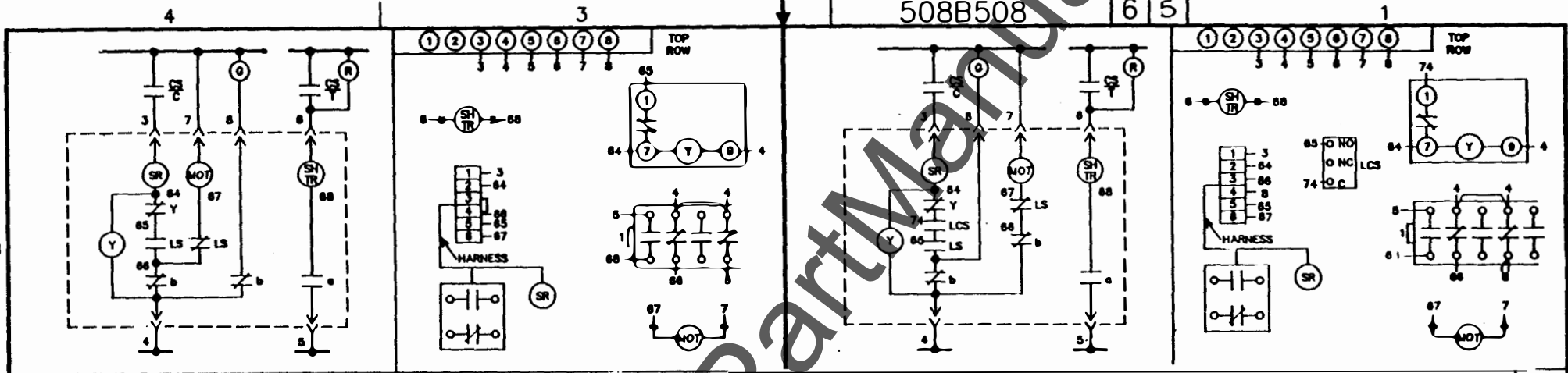

1	2	3	4	5
REVISION	T0011789	T0011090	T0042790	

ALL REV. NOTES LISTED ON SHEET 22 AND OTHER SHEETS LIST REV. NO. ONLY

ELECTRICAL COMPONENTS DIVISION
PITTSBURGH, PA 15275

Westinghouse Electric Corporation

DS CIRCUIT BREAKER
PWR OPERATED MECH STD
SPRINGS CHARGED AFTER BRKR OPENS

S/L B
THOMAS

FILE NO. T0050006
SHEET NO. 8 OF 72 SHEETS

DWG. NO. 508B508

REV. 7 5

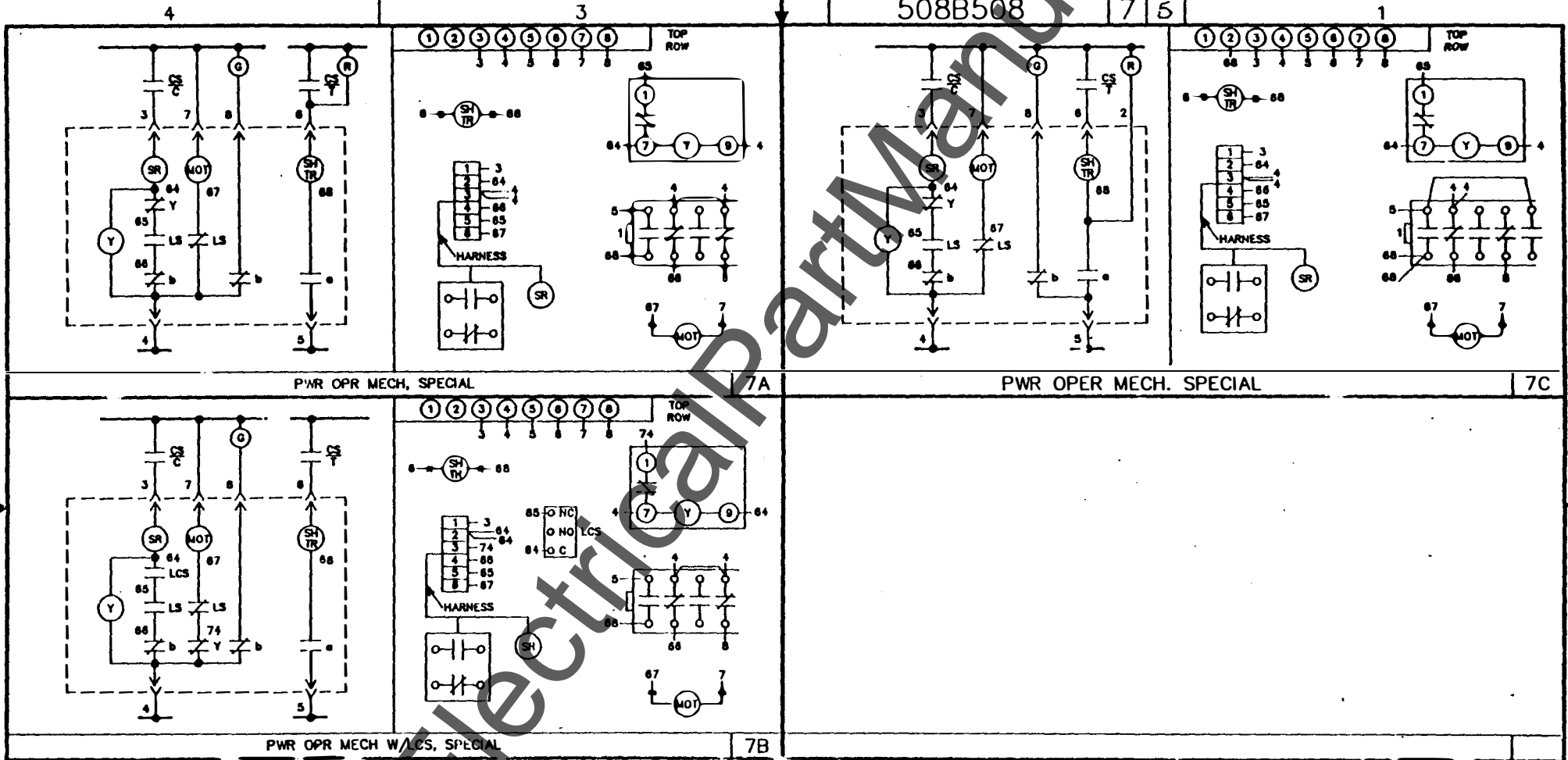

1	2	3	4	5
REVISION	T0011789	T0011090	T0042790	

ALL REV. NOTES LISTED ON SHEET 22 OF OTHER SHEETS LIST REV. NO. ONLY

ELECTRICAL COMPONENTS DIVISION
PITTSBURGH, PA 15275

Westinghouse Electric Corporation 

D & P TECHNOLOGY & QUALITY DIV. TECHNICAL CENTER

FILE DS CIRCUIT BREAKER
PWR OPERATED MECH SPECIAL
CL SPRINGS CHARGED AFTER MKR CLOSES

SIZE B FROM NO. DWG. NO. 508B508

THOMAS FILE NO. T0050007 SHEET NO. 7 OF 72 SHEETS

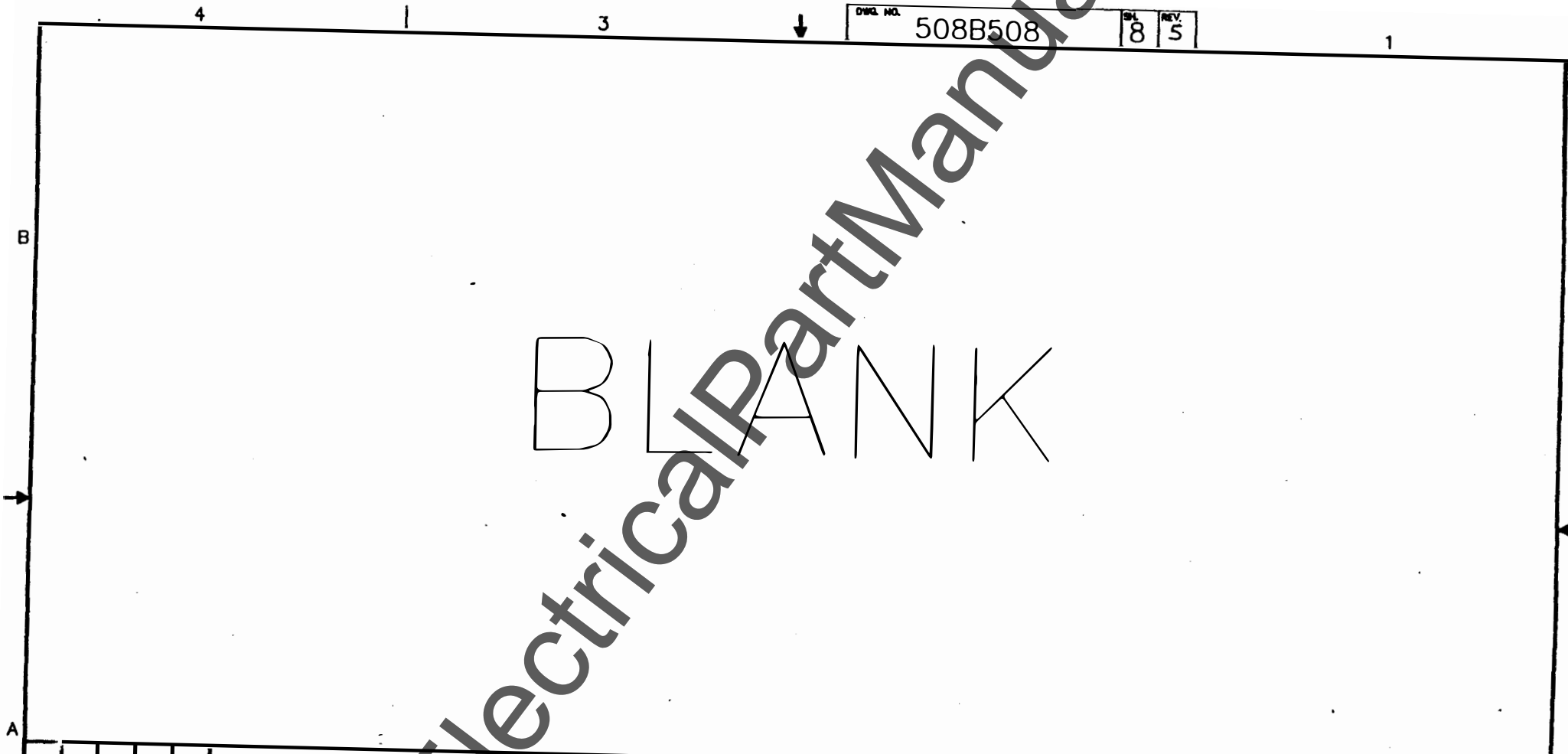

DWG. NO. 508B508 SHEET 8 REV. 5

BLANK

1	
2	T0011785
3	T0011090
4	T0042790
5	

ALL REV. NOTES LISTED ON SHEET 22 ALL OTHER SHEETS LIST REV. NO. ONLY

ELECTRICAL COMPONENTS DIVISION
PITTSBURGH, PA 15275

DFTL. ADLETT/CS & CS
 A. D. MCCURRYE
 APPD. BLODL
 THOMAS

Westinghouse Electric Corporation 
 I. & P. TECHNOLOGY & QUALITY DIV. TECHNICAL CENTER

TITLE: DS CIRCUIT BREAKER

SIZE: B FROM NO. DWG. NO. 508B508

SCALE FILE NO. T0050008 SHEET NO. 8 OF 22 SHEETS

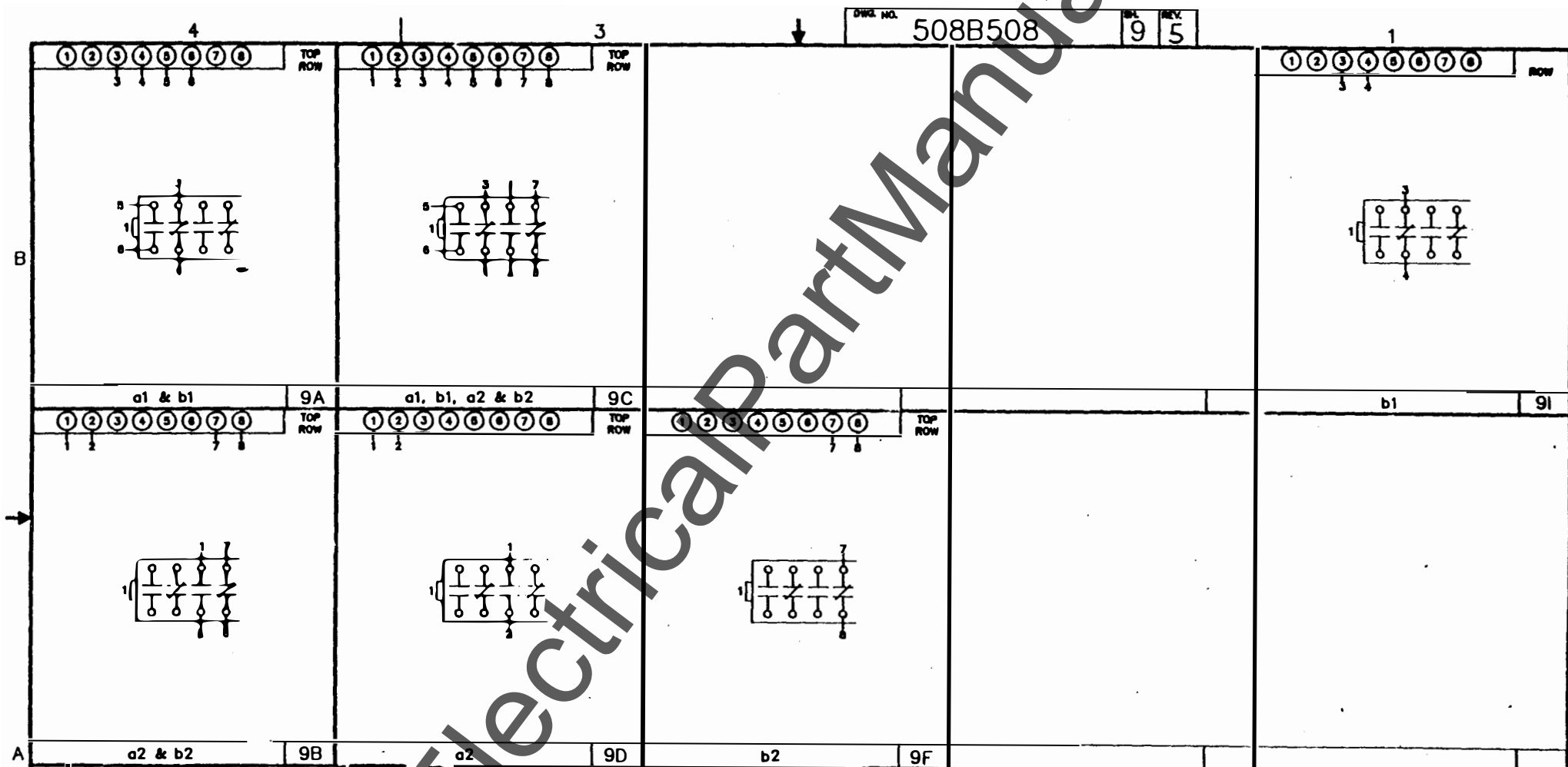

DWG. NO. 508B508
 9 5

1	2	3	4	5
REV. NO.	TOC:1789	T0011090	T0042790	
DATE				

ELECTRICAL COMPONENTS DIVISION
 PITTSBURGH, PA 15275

Westinghouse Electric Corporation 

D & P DEPARTMENT QUALITY DIV. TECHNICAL GEN. 4

TITLE
 DS CIRCUIT BREAKER
 AUXILIARY SWITCH 1LB

SIZE 13
 SCALE

FIG. NO. TQ050009
 SHEET NO. 9 OF 22 SHEETS

DWG. NO. 508B508

ALL REV. NOTES LISTED ON
 SHEET 22 ALL OTHER SHEETS
 LIST REV. NO. ONLY

DRG. NO. 508B508

REV. 10 5

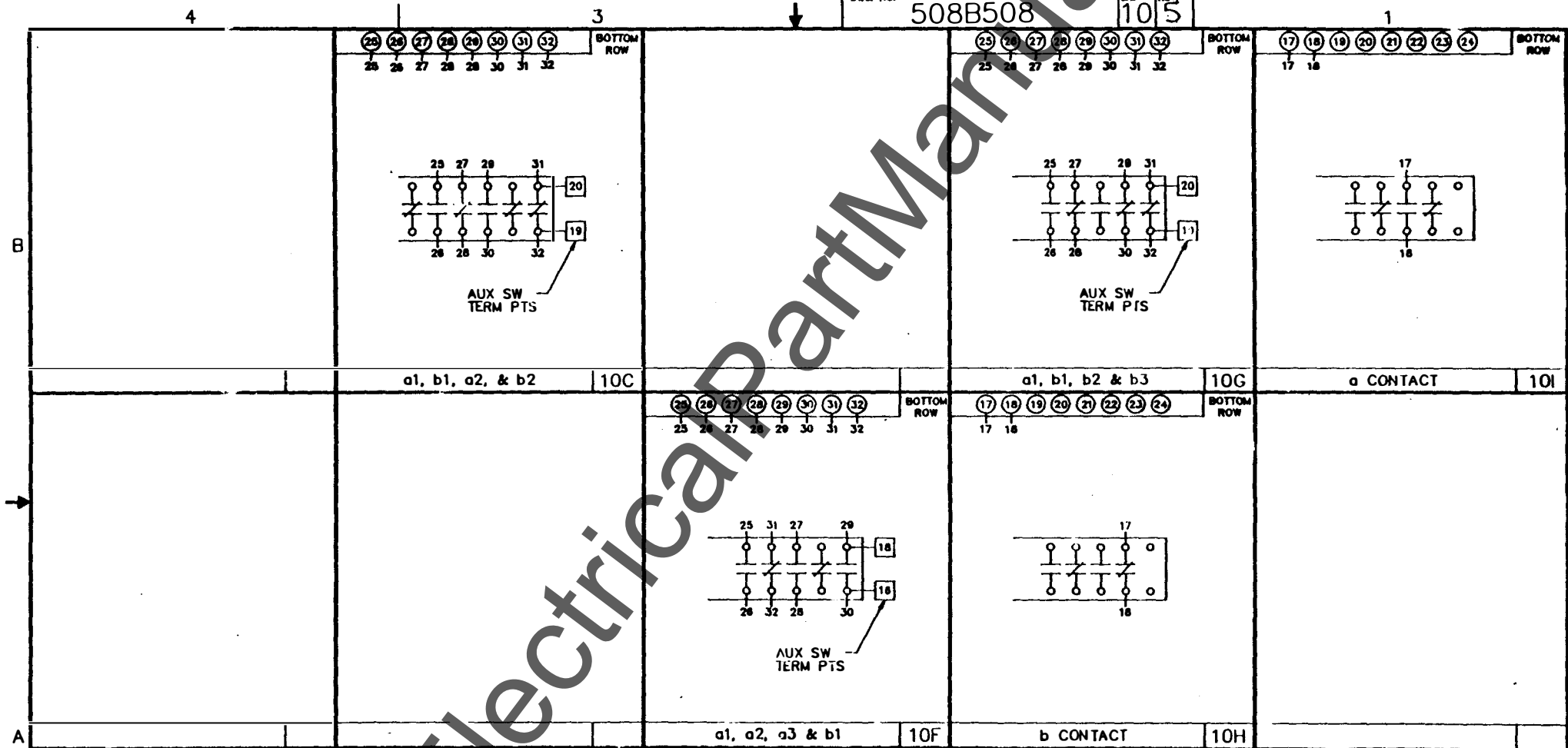

1	2	3	4	5
REV. NO.	T0011759	T001090	T0042790	
PL.				

ALL REV. NOTES LISTED ON SHEET 22 ALL OTHER SHEETS LIST REV. NO. ONLY

ELECTRICAL COMPONENTS DIVISION
PITTSBURGH, PA 15205

DFTL. AQUETTI/① & CS APPD. MCGUIRE APPD. BLUDD THOMAS		Westinghouse Electric Corporation <small>TECHNOLOGY & QUALITY DIV. TECHNICAL CENTER</small> FILE DS CIRCUIT BREAKER AUXILIARY SWITCH 1RB SIZE B SCALE	
FILE NO. T0050010 SHEET NO. 10 OF 21 SHEETS		DWG. NO. 508B508	

DWG. NO. 508B508 SH. REV. 11/5

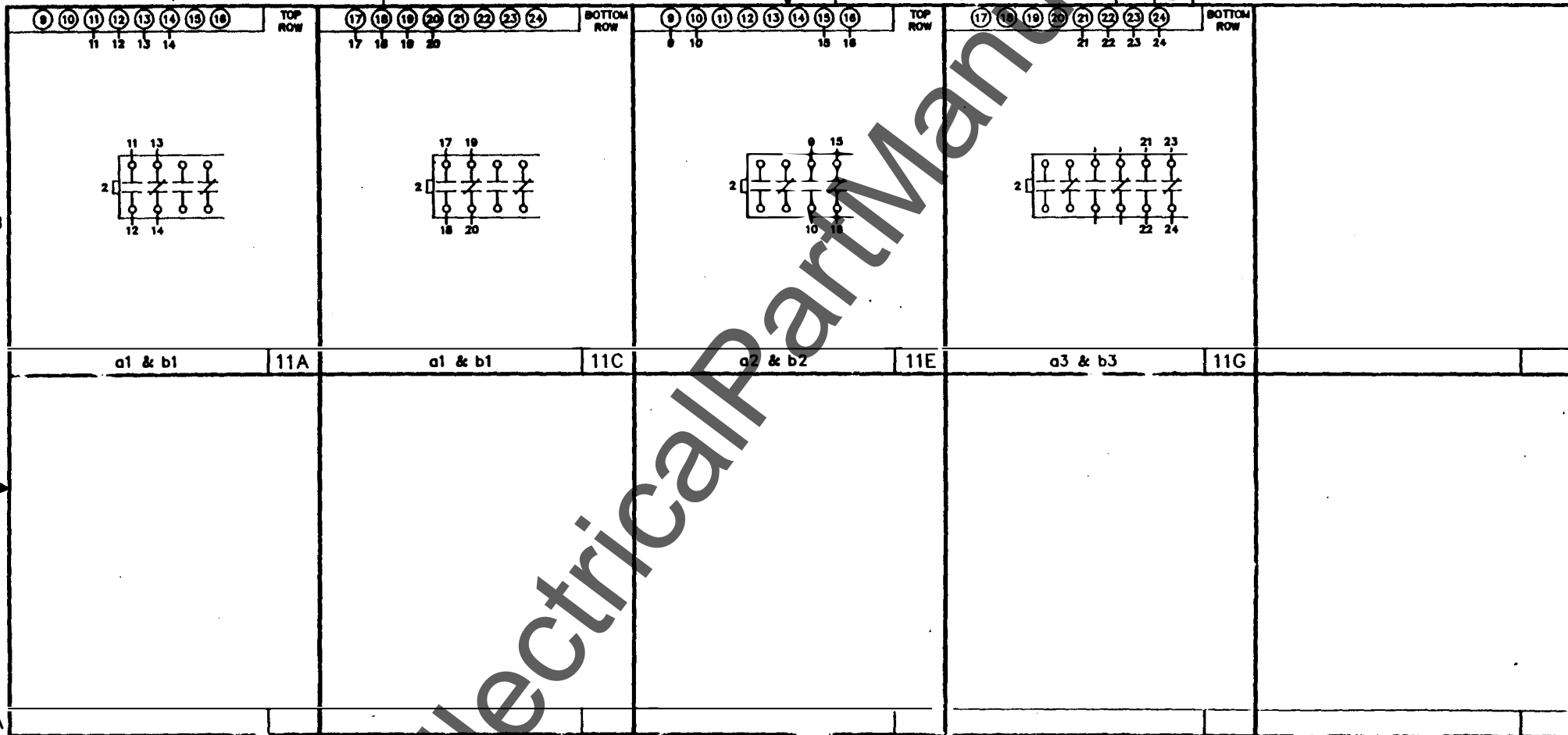

1	2	3	4	5
REASON	TQ011789	TQ011090	TQ042790	
DATE				

ALL REV. NOTES LISTED ON SHEET 22 ALL OTHER SHEETS LIST REV. NO. ONLY

ELECTRICAL COMPONENTS DIVISION
PITTSBURGH, PA 15275

Westinghouse Electric Corporation 
D & P TECHNOLOGY & QUALITY DIV. TECHNICAL CENTER

DS CIRCUIT BREAKER
AUXILIARY SWITCH 2

DR. IN. AGUETI/M & CS
APPD. MODIF. NE
APPD. BUOOL
THOMAS

SIZE B
SCALE
DWG. NO. 508B508
TQ050011 SHEET NO. 11 OF 22 SHEETS

DWG. NO. 508B508

SPL 12 REV. 5

BLANK

B
A

1	2	3	4	5
REVISED	T0011789	T0011090	T0042790	
DATE				

ALL REV. NOTES LISTED ON SHEET 22 AND OTHER SHEETS MUST REV. NO. ONLY

DFTL. ASSEMBLY/CS & CS
 APPD. MCGUIRE
 AUTH. BUDD
 THOMAS

ELECTRICAL COMPONENTS DIVISION
 PITTSBURGH, PA 15275

Westinghouse Electric Corporation 
 D & P TECHNOLOGY & QUALITY DIV. TECHNICAL CENTER

TITLE DS CIRCUIT BREAKER

SIZE 8 1/2" x 11" DWG. NO. 508B508

SCALE FILE NO. T0050012 SHEET NO. 12 OF 22 SHEETS

W. ElectricalPartManuals.com

DWG. NO. 508B508

SHEET 13 REV. 5

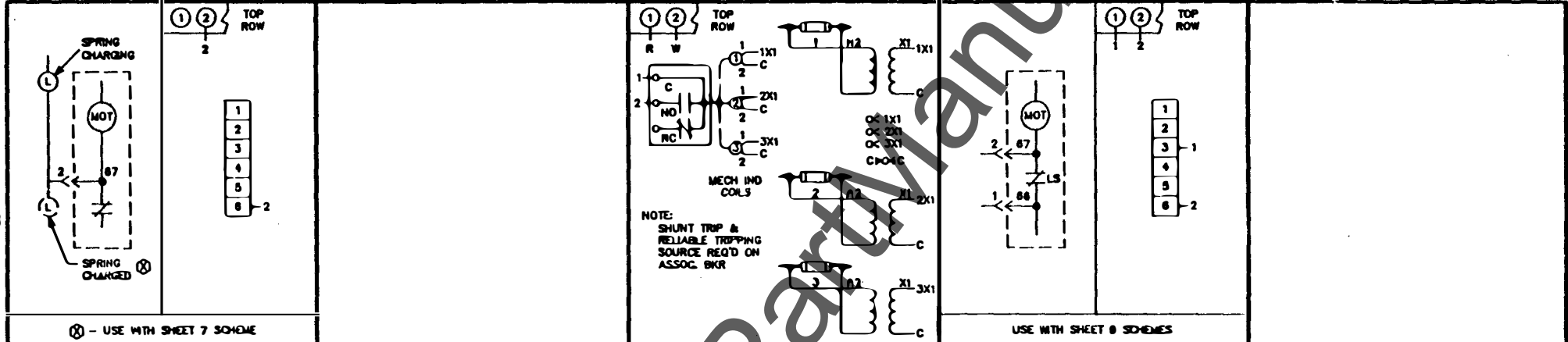

⊗ - USE WITH SHEET 7 SCHEME

USE WITH SHEET 8 SCHEMES

MOTOR/LIM SW EXT CONN 13A

LIMITER TRUCK 13E

LIMIT SW EXTERNAL CONN 13G

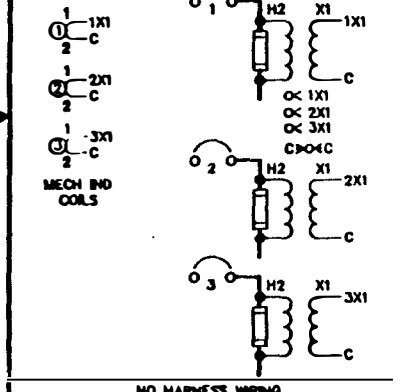

17 18 19 20 21 22 23 24 BOTTOM ROW

17 18 19 20 21 22 23 24 BOTTOM ROW

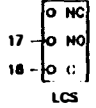
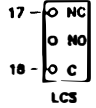

NO HARNESS WIRING

BLOWN LIM IND, 3P 13B

LATCH CHECK SW N.O. CONT 13D

LATCH CHECK SW N.O. CONT 13F

1	2	3	4	5
REVISION	T0011789	T0011090	TOC-2790	

ALL REV. NOTES LISTED ON SHEET 22 ALL OTHER SHEETS LIST REV. NO. ONLY

ELECTRICAL COMPONENTS DIVISION
PITTSBURGH, PA 15275

DFTM	ADJETH/ @H & CS
APPR	MCQUITE
APPL	BLUOL
THOMAS	

Westinghouse Electric Corporation

D & P TECHNOLOGY & QUALITY DIV. TECHNICAL CENTER

TITLE: DS CIRCUIT BREAKER MISCELLANEOUS

DWG. NO. 508B508

FILE NO. TQ050013 SHEET NO. 13 OF 22 SHEETS

DWG. NO. 508B508

SHEET NO. 14 REV. 5

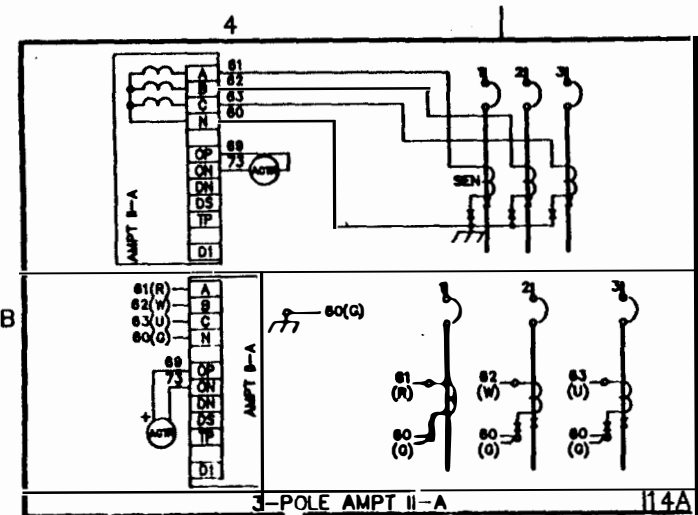

3-POLE AMPT II-A 114A

1	REVISION
2	TQ011789
3	TQ011090
4	TQ042790
5	

ALL REV. NOTES LISTED ON SHEET 22 ALL OTHER SHEETS LIST REV. NO. ONLY

ELECTRICAL COMPONENTS DIVISION
PITTSBURGH, PA 15275

Westinghouse Electric Corporation 

D & P TECHNOLOGY & QUALITY DIV. 

DS CIRCUIT BREAKER
SERIES TRIP AMPTECTOR
11A, 3P

FILE NO. TQ050014
DWG. NO. 508B508

SCALE SHEET NO. 14 OF 22 SHEETS

DWG. NO. 508B508 15 REV. 5

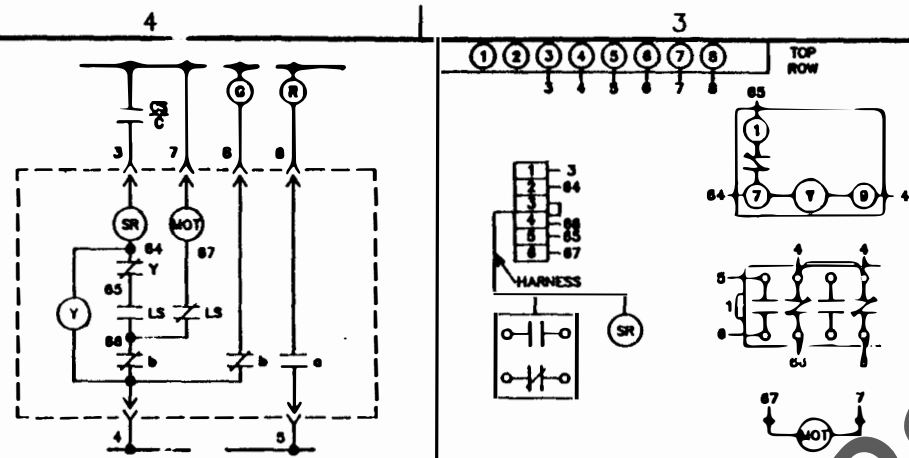

PWR OPR MECH W/O SHUNT TRIP 15A

OMIT ONE OF ITEM 9 OR 20 DWG. 8295A08
 SEE FIGURE 2B, 2C, OR 2D
 OMIT STD. SENSOR FRAME
 GND. CONN.— ONE OF ITEM 9 OR 20
 OF DWG. 8295A08
 SEE FIGURE 2B, 2C, OR 2D.

1	2	3	4	5
ITEM NO.	TO011789	TO011090	TO042790	

ALL REV. NOTES LISTED ON SHEET 22 ALL OTHER SHEETS LIST REV. NO. ONLY

ELECTRICAL COMPONENTS DIVISION
 PITTSBURGH, PA 15275

Westinghouse Electric Corporation
 D & P TECHNOLOGY & QUALITY DIV. TECHNICAL CENTER

FILE DS CIRCUIT BREAKER SPECIAL

SCALE B FILE NO. 10050015 SHEET NO. 18 OF 22 SHEETS

W. Electrical Part Manuals . CO

DWG. NO. 508B508

REV. 16 5

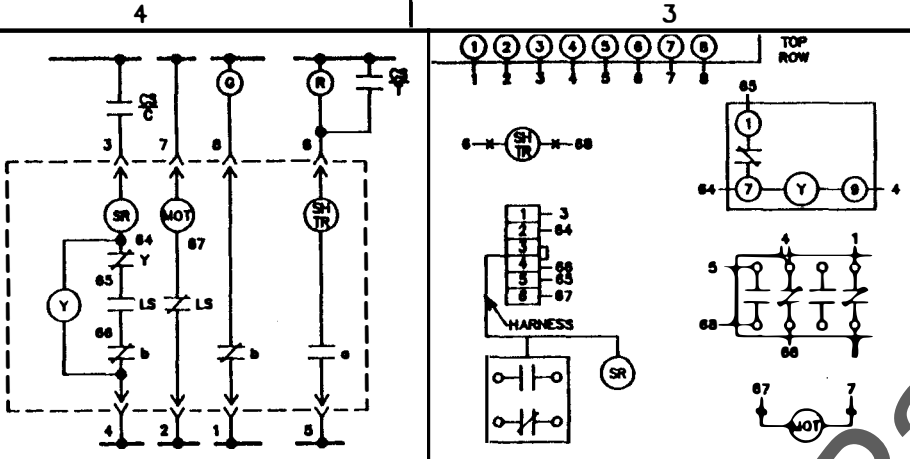

PWR OPR MECH W/MOT ON SEP CONN
CAUTION: USE ONLY 120 VAC MOTOR WITH 48 VDC SR COIL

16A

1	
2	T0011789
3	T0011090
4	T0042790
5	

ALL REV. NOTES LISTED ON SHEET 22 ALL OTHER SHEETS LIST REV. NO. ONLY

ELECTRICAL COMPONENTS DIVISION
PITTSBURGH, PA 15275

Westinghouse Electric Corporation

DS CIRCUIT BREAKER SPECIAL

SIZE B
SCALE
Dwg. No. 508B508

FILE NO. T0050016 SHEET NO. 18 OF 23 SHEETS

www.ElectricalPartManuals.com

DWG. NO. 508B508 SHEET 17 OF 22

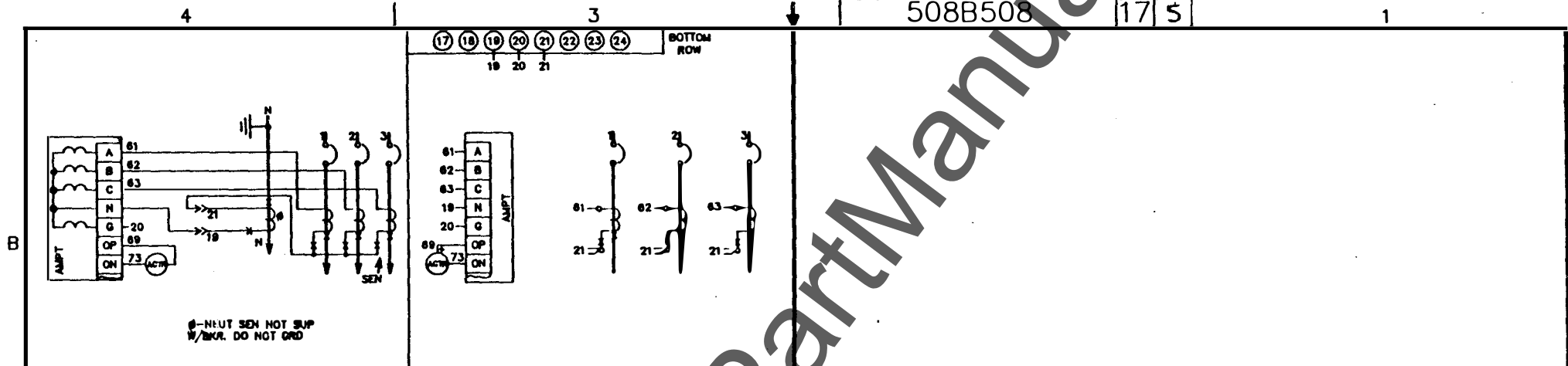

SERIES TRIP WITH GROUND WITH NEUT CONN 17A

1	
2	T0011789
3	T0011090
4	T0042790
5	

ALL REV. NOTES LISTED ON SHEET 22 ALL OTHER SHEETS LIST REV. NO. ONLY

ELECTRICAL COMPONENTS DIVISION PITTSBURGH, PA 15275	
Westinghouse Electric Corporation	
D & P TECHNOLOGY & QUALITY DIV. TECHNICAL CENTER	
TITLE DS CIRCUIT BREAKER OEM SPECIAL	
DESIGNER THOMAS	DWG. NO. 508B508
SCALE B	FILE NO. TQ050017
SHEET NO. 17 OF 22 SHEETS	

www.ElectricalPartManuals.com

DWG. NO. 508B508

18 5

1

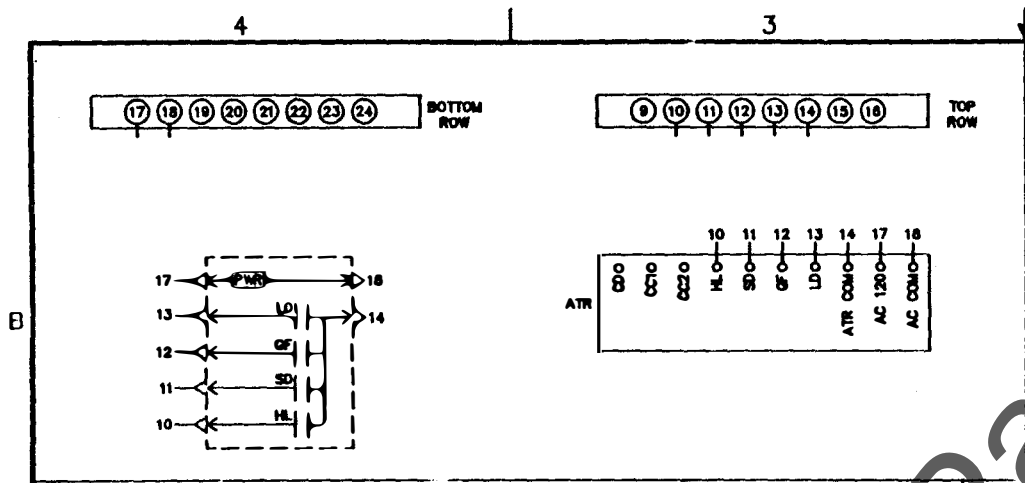

DIGITRIP 600, 700, 800

18A

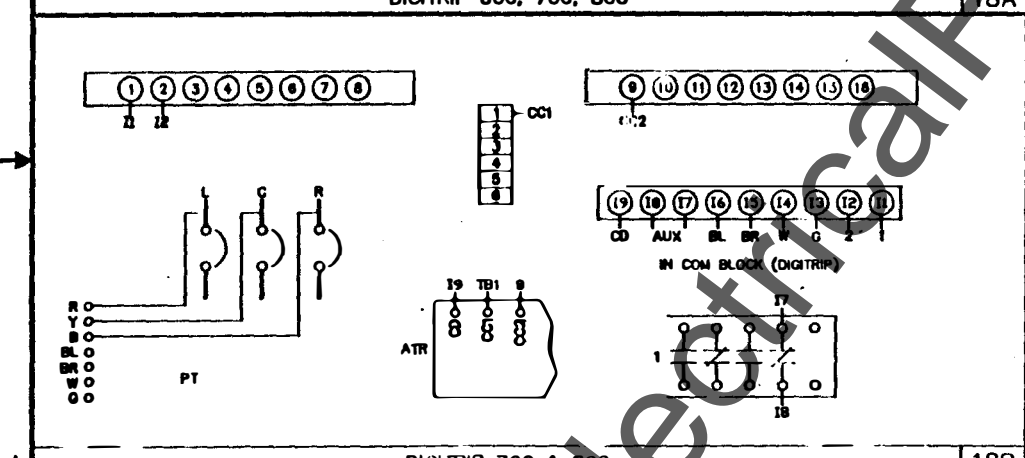

DIGITRIP 700 & 800

18B

1	2	3	4	5
REVISED	T0011789	T0011090	T0042790	

ALL REV. NOTES LISTED ON SHEET 22 ALL OTHER SHEETS LIST REV. NO. ONLY

ELECTRICAL COMPONENTS DIVISION
PITTSBURGH, PA 15275

Westinghouse Electric Corporation 
D & P TECHNOLOGY & QUALITY DIV. TECHNICAL CENTER

FILE DS CIRCUIT BREAKER
RMS DIGITRIP

SIZE 11
SCALE
FILE NO. T0050018
DRAWING NO. 508B508
SHEET NO. 18 OF 22 SHEETS

www.ElectricalPartManuals.com

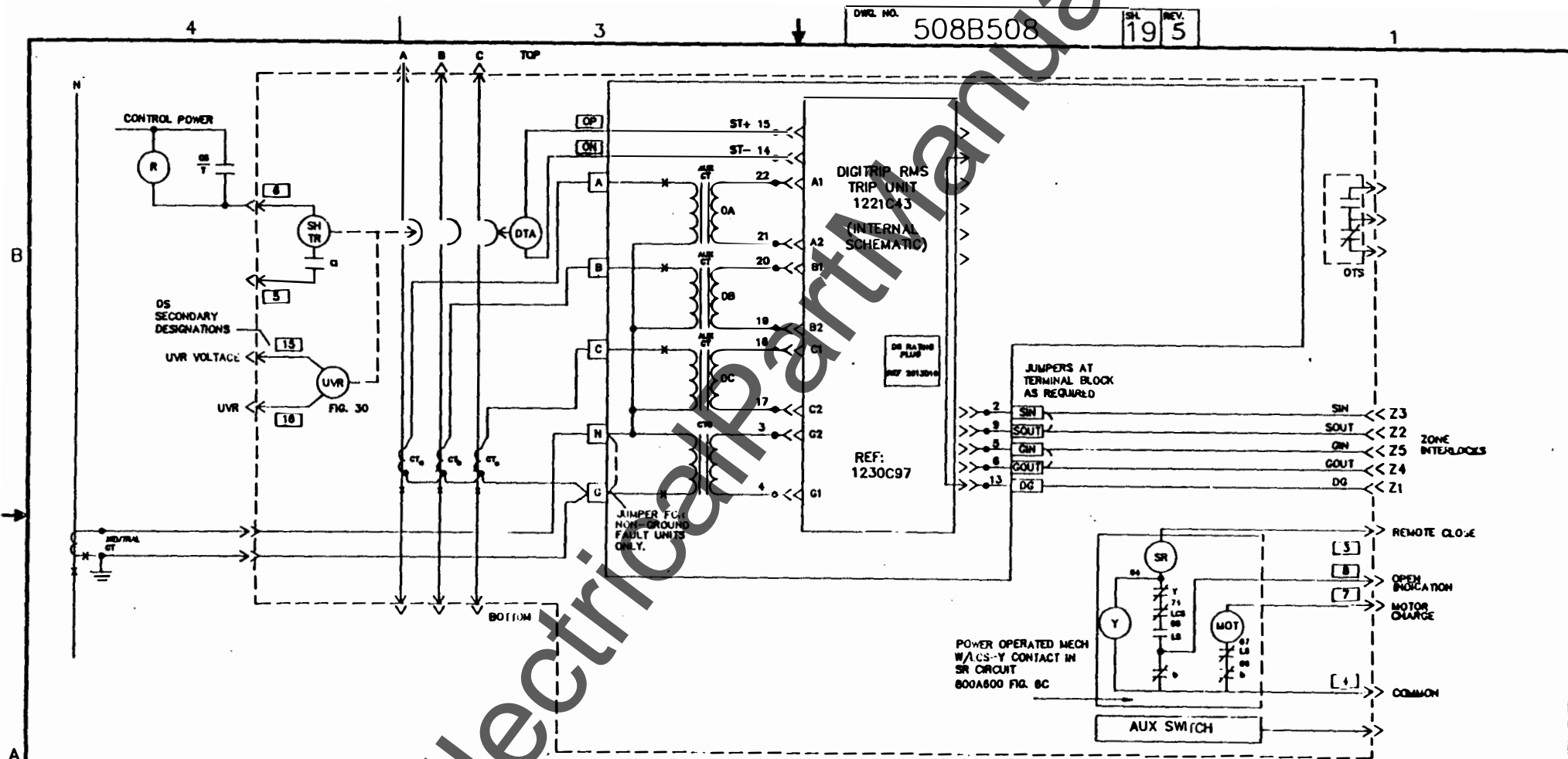

1	REVISION
2	TO011789
3	TO011090
4	TO042790
5	

ALL REV. NOTES LISTED ON SHEET 22 ALL OTHER SHEETS LIST REV. NO. ONLY

ELECTRICAL COMPONENTS DIVISION
PITTSBURGH, PA 15275

Westinghouse Electric Corporation
D & P TECHNOLOGY & QUALITY DIV. TECHNICAL CENTER

TITLE
SCHEMATIC DIGITRIP T500 DS BREAKER

SIZE B PSCH. NO. DWG. NO. 508B508

SCALE FILE NO. TQ050019 SHEET NO. 19 OF 22 SHEETS

www.ElectricalPartManuals.com

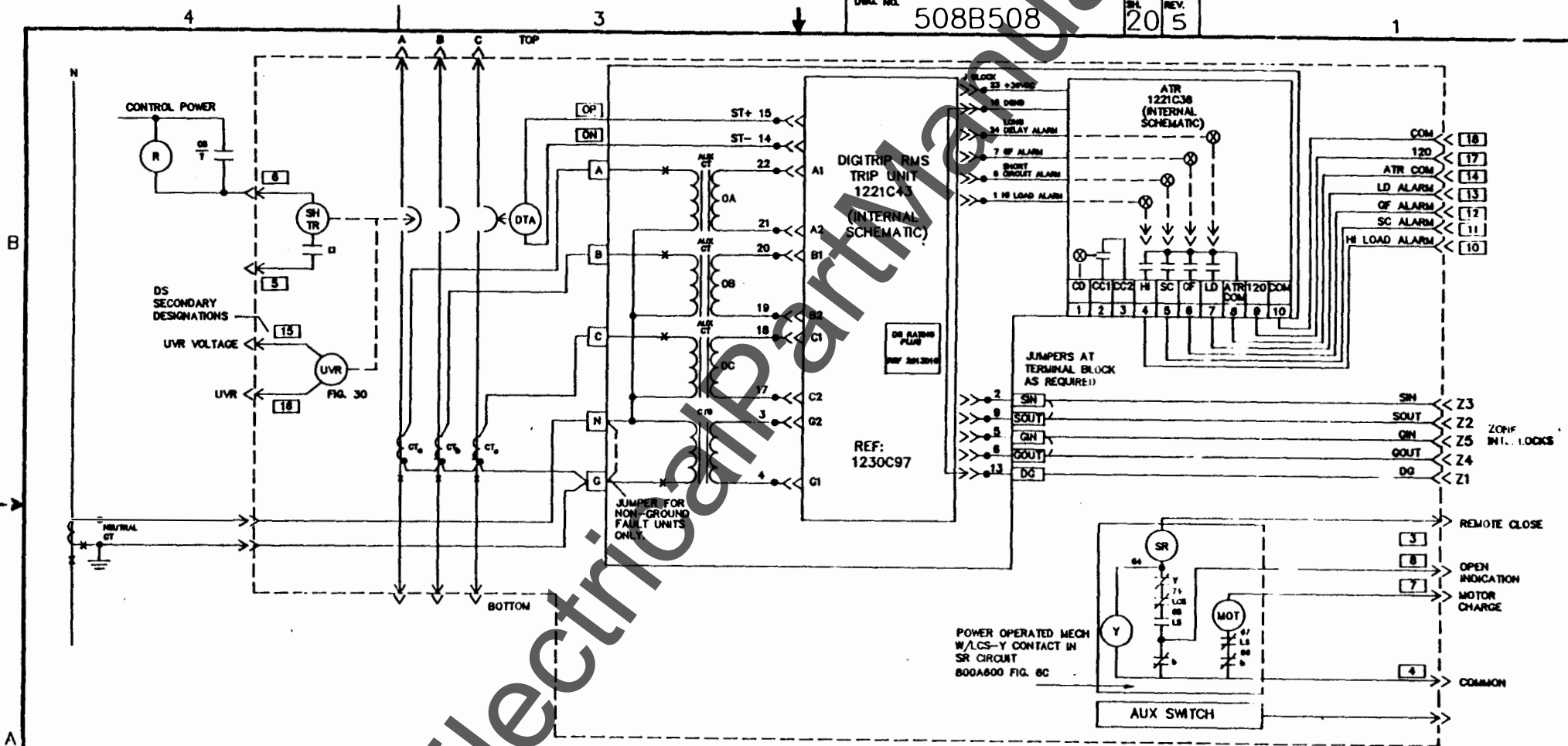

1	REV. NO.
2	TQ011789
3	TQ011090
4	TQ042790
5	

ALL REV. NOTES LISTED ON SHEET 22 ALL OTHER SHEETS LIST REV. NO. ONLY

ELECTRICAL COMPONENTS DIVISION
PITTSBURGH, PA 15275

Westinghouse Electric Corporation

D & P FOR INVENTORY & QUALITY DIV. TECHNICAL CENTER

TITLE: **SCHEMATIC DIGTRIP T600 DS BREAKER**

DESIGNER: THOMAS	SIZE: B	FORM NO.:	DWG. NO. 508B508
DATE:	SCALE:	SHEET NO.:	TQ050020

SHEET NO. 20 OF 22 SHEETS

www.ElectricalPartManuals.com

DWG. NO. 508B508 REV. 21 4

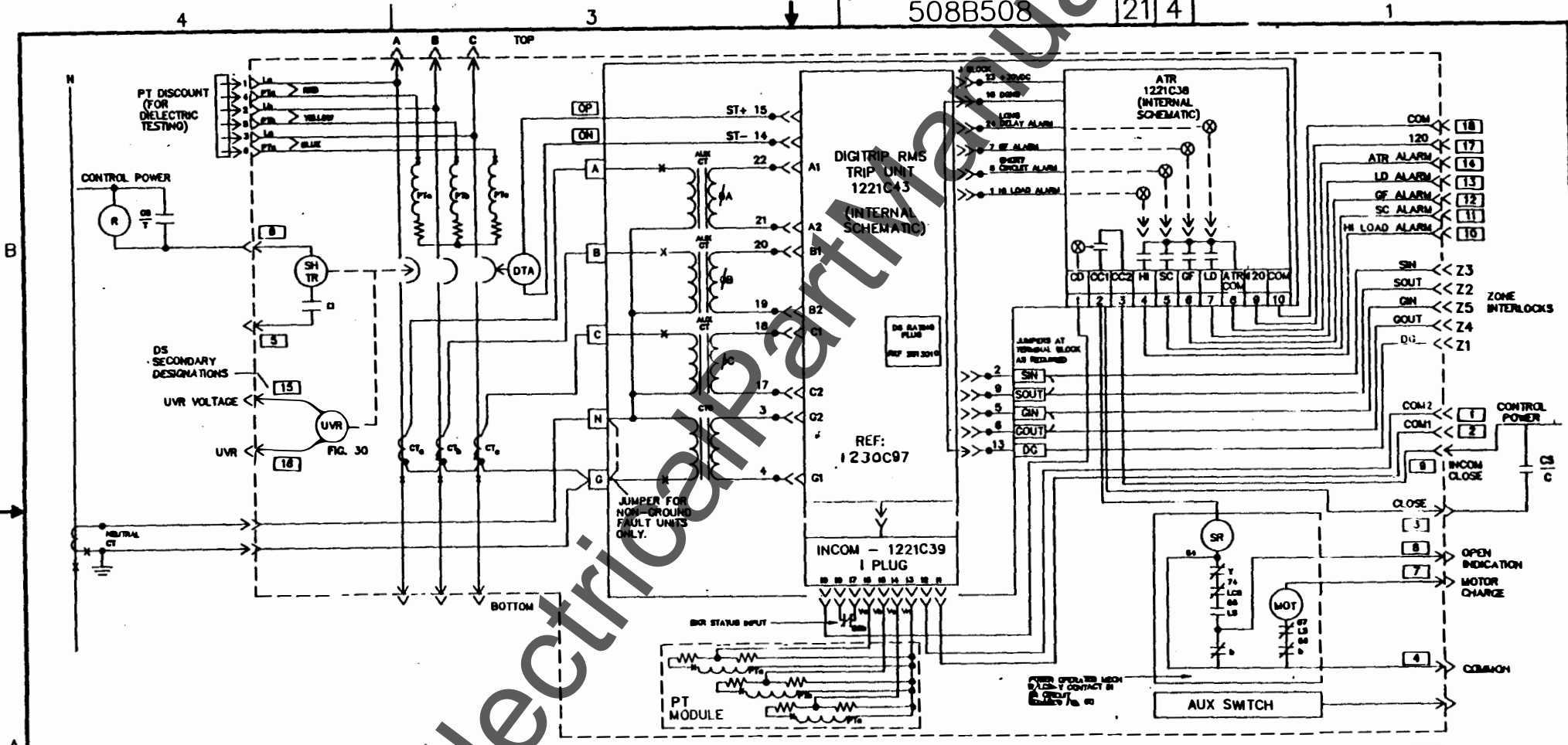

1	2	3	4
REVISION	T0011789	T0011090	T0042790
IT.			

ALL REV. NOTES LISTED ON SHEET 22 ALL OTHER SHEETS LIST REV. NO. ONLY

ELECTRICAL COMPONENTS DIVISION
PITTSBURGH, PA 15275

Westinghouse Electric Corporation

1 & P. I. CONSTRUCTION & QUALITY DIV. MEDICAL CENTER
TITLE
SCHEMATIC T700 & T800
DS BREAKER

UP. INL. AQUETTI / M & CS	SIZE B	FILE NO. T0050021	DRG. NO. 508B508
APPD. MCGUIRE	SCALE	SHEET NO. 21 OF 22 SHEETS	
APPD. BUDG.	THOMAS		

www.ElectricalPartManuals.com

REVISON	1
RNIB579	
RNIB646 OLD FILM NO. WAS TQ090188 SH.11 FIG.11G a3 & b3 WERE a2 & b2.DEV-AUX SW 2 WIRE 21,22,23,24 RELOCATED AGUJETTI 12/3/88 McGUFFIE 12/5/88 BUDOL 12/5/88 TQ011789	2
RNIB674 FIG. 10,15,16 & 18 WERE UPDATED E&SD 1-3-90 B. AGUJETTI	3
RNIB889 SH. 19, 20, 21 WERE BLANK SH. 1-7-18 WERE UPDATED E&SD 4-3-90 B. AGUJETTI	4
RN-1B988 <i>11/11/90</i> SH. 4 4D CHANGED 4M & N WERE NOT ON C. PALMIER 11-14-90	5

ALL REV. NOTES LISTED ON SHEET 22 ALL OTHER SHEETS LIST REV. NO. ONLY

ORTL AGUJETTI/01 & CS APRIL LOCARTE APRIL BUDOL 11-14-90	ELECTRICAL COMPONENTS DIVISION PITTSBURGH, PA 15275 Westinghouse Electric Corporation DS CIRCUIT BREAKER SUB NOTES	FILE NO. T0050022 SHEET NO. 22 OF 22 SHEETS
--	--	--

REVISON	
REVISON	
REVISON	
REVISON	

DWG. NO. 508B508
 22 REV. 5

ElectricalPartManuals.com

www.ElectricalPartManuals.com