



RENEWAL PARTS

Type AM-4.16-350-2 Magne-Blast Circuit Breakers

Note: The ML-13 operating mechanism is not included in this publication.
Refer to GEF-4379.

Ordering Instructions

1. Always specify the complete nameplate data of the breaker.
2. Specify the quantity, catalog number (if listed), reference number (if listed) description, and this bulletin number.
3. Standard hardware, such as screws, bolts, nuts, washers, etc., is not listed in this bulletin. Such items should be purchased locally.
4. For prices, refer to the nearest office of the General Electric Company.

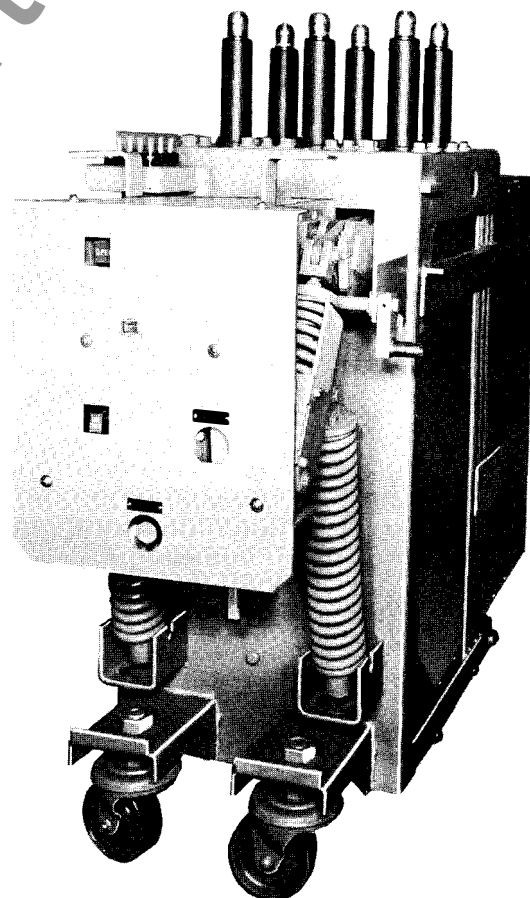

Data is subject to change without notice.

TYPE AM-4.16 MAGNE-BLAST CIRCUIT BREAKER

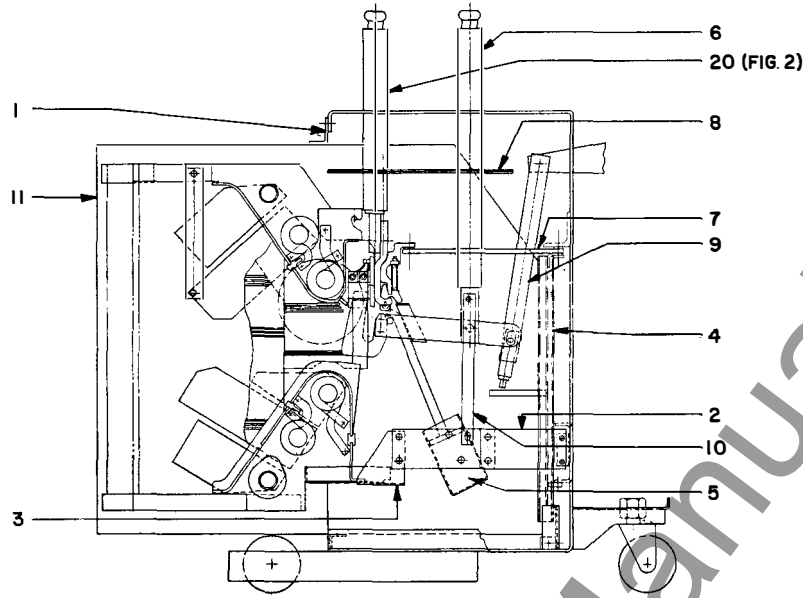

A. Breaker, Type AM-4.16-350

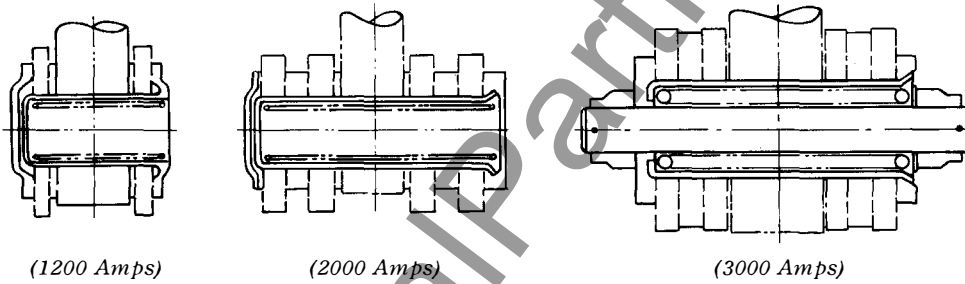

B. Hinge pin assembly (Ref. No. 12)

Fig. 1. Cross section views

NOTE: For recommended parts for normal maintenance, refer to back cover.

TYPE AM-4.16-350 BREAKER (REFER TO FIG. 1)

Ref. No.	Catalog Number for Type AM-4.16-350			No. Req'd	Description
	1200 Amp	2000 Amp	3000 Amp		
1	-----	-----	073-265C0151P028	3	Box barrier clamp
2	073-132C2745P005	073-132C2745P005	132C2745P005	6	Arc chute support, left
3	258C0619G012	258C0619G012	258C0619G012	3	Arc chute clamp
4	132C2741G001	132C2741G001	-----	1	Vertical barrier, left
4	132C2741G002	132C2741G002	-----	1	Vertical barrier, center
4	132C2741G003	132C2741G003	-----	1	Vertical barrier, right
4	-----	-----	619C0453G001	1	Vertical barrier, top
4	-----	-----	619C0453G003	1	Vertical barrier, bottom
5	132C2745G001	132C2745G001	132C2745G001	3	Booster cylinder
6	845D0123G002	688C0515G005	619C438G002	3	Front bushing
7	114C5380P011	114C5380P012	-----	6	Horizontal barrier, lower
8	258C0614P006	258C0614P007	-----	6	Horizontal barrier, upper
8	-----	-----	619C0463P010	6	Horizontal barrier
9	281B0708G008	281B0708G008	802B0730G001	3	Operating rod assembly
10	114C5490P010	114C5490G010	132C2745P009	3	Connection bar
11	132C2742G001	132C2742G001	-----	1	Box barrier assembly
11	-----	-----	619C0467G001	3	Box barrier assembly
12	898B0282G001	898B0282G002	898B0282G003	6	Hinge pin assembly

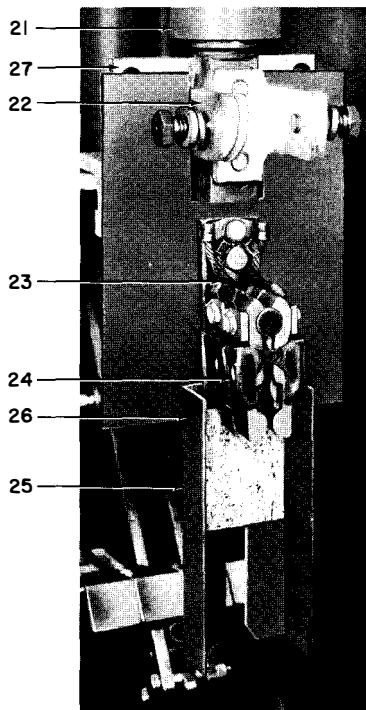

Fig. 2. Rear bushing assembly (Ref. No. 20)

REAR BUSHING ASSEMBLY (REFER TO FIG. 2 AND 4)

Ref. No.	Catalog Number for Type AM-4.16-350			No. Req'd	Description
	1200 Amp	2000 Amp	3000 Amp		
20	073-213X0344G045	073-213X0344G046	073-132C2749G001	3	Rear bushing assembly
21	845D0124G006	688C0516G008	619C438G001	3	Bushing
22	619C0443P017	619C0443P007	132C2746P005	3	Guide and support for interrupter
23	208A8017G001	208A8017G001	208A8017G001	3	Flexible connector, left, long
23	218A8017G002	208A8017G002	208A8017G002	3	Flexible connector, right, long
23	208A8017G003	208A8017G003	208A8017G003	3	Flexible connector, left, short
23	208A8017G004	208A8017G004	208A8017G004	3	Flexible connector, right, short
24	213X0344G032	213X0344G032	213X0344G032	3	Stationary arcing contact assembly
25	208A8016G001	208A8016G001	208A8016G001	3	Throat barrier assembly
26	132C2745P006	132C2745P007	132C2728P019	3	Baffle
27	258C0666P010	258C0666P010	134C3526P001	3	Arcing contact support
†28	06445087P004	06445087P004	619C0464P009	3	Buffer
*†29	06557243P002	06557243P002	06557243P002	6	Clamp for buffer
†30	114C5382P002	114C5382P002	-----	24	Primary contact finger
†30	-----	-----	114C5382P002	36	Primary contact finger
†31	121A5964P001	121A5964P001	-----	24	Primary contact finger spring
†31	-----	-----	414A0180P001	36	Primary contact finger spring
*†32	03663094P005	03663094P005	-----	24	Spacer
*†33	N312P2542B	N312P2542B	-----	24	Spring guide
*†33	-----	-----	N312P2542B	36	Spring guide
†34	828C0782P005	828C0782P005	132C2738P006	3	Spring retainer
*†35	828C0782P008	828C0782P008	619C487P015	3	Contact finger retainer

*Not Illustrated

†See Fig. 4, pg. 5

www.ElectricalPartManuals.com

GENERAL ELECTRIC COMPANY • BREAKER PLANT OPERATION • PHILADELPHIA, PA 19142

11-84 (1000)

GENERAL  ELECTRIC

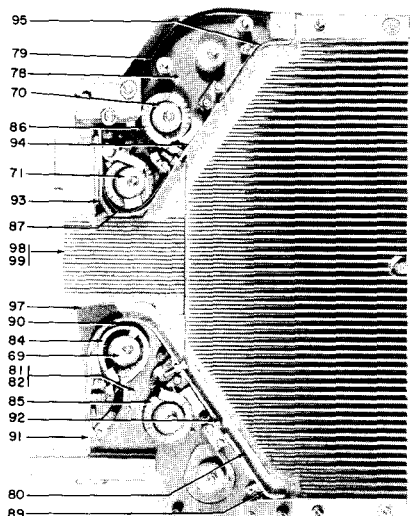

Side cover removed

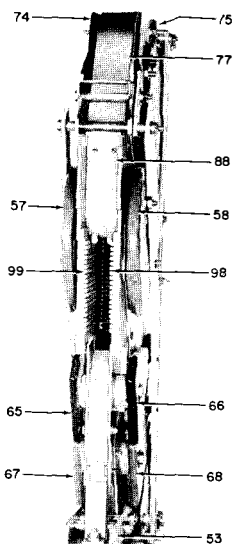

Front view

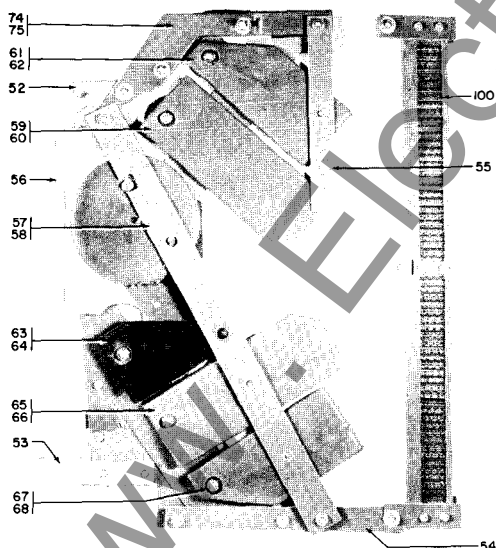

Complete assembly (Ref. No. 50)

Fig. 3. Interrupter assembly

INTERRUPTER ASSEMBLY (REFER TO FIG. 3)

Ref. No.	Catalog Number	No. Req'd	Description
50	073-213X0215G023	3	Interrupter assembly, complete
*51	264B0100G018	3	Interrupter sides
52	132C2721P001	3	Upper support
53	132C2721G002	3	Lower support
54	132C2728P015	6	Lower brace
55	132C2738P002	6	Rear brace
56	132C2738P001	6	Side brace
57	132C2776G002	3	Upper pole pieces, left
58	132C2776G003	3	Upper pole pieces, right
59	132C2736G003	3	Upper pole pieces, left
60	132C2736G004	3	Upper pole pieces, right
61	132C2736G005	3	Upper pole pieces, left
62	132C2736G006	3	Upper pole pieces, right
63	132C2736G007	3	Lower pole pieces, left
64	132C2736G008	3	Lower pole pieces, right
65	132C2736G009	3	Lower pole pieces, left
66	132C2736G010	3	Lower pole pieces, right
67	132C2736G011	3	Lower pole pieces, left
68	132C2736G012	3	Lower pole pieces, right
69	108B5521G002	3	Core assembly, 2 11/16 in.
70	108B5521G005	12	Core assembly, 2 13/16 in.
71	108B5521G007	3	Core assembly, 2 15/16 in.
*72	414A0102P008	3	Stud
*73	137A9163P002	18	Bushing
74	962C0750P009	3	Interrupter support, left
75	962C0750P010	3	Interrupter support, right
*76	962C0750P003	3	Block
77	962C0750P002	3	Dust shield
78	265C0163P008	6	Coil support, upper
79	265C0163P009	6	Barrier, upper
80	421A0201P001	6	Lower shield
81	132C2745P011	3	Coil support, left
82	132C2745P012	3	Coil support, right
*83	414A0198P001	3	Insulation seal
84	152C5905G010	3	Coil, #1 lower
85	152C5905G012	3	Coil, #2 lower
86	152C5905G005	3	Coil, #2 upper
87	152C5905G003	3	Coil, #1 upper
88	108B5520P001	3	Insulation plate
89	265C0154G009	3	Runner, lower #3
90	132C2746G001	3	Runner, lower #1
91	132C2746G002	3	Runner, lower (conn)
92	132C2708G003	3	Runner, lower #2
93	132C2708G002	3	Runner, upper #1
94	132C2708G006	3	Runner, upper #2
95	265C0154G003	3	Runner, upper #3
*96	456A0891P210	3	Sleeve
97	132C2735P007	6	Lower insulation
98	134C3595G001	3	Throat cooler assembly, right
99	134C3595G002	3	Throat cooler assembly, left
100	114C5443G002	3	Muffler assembly

*Not illustrated

TYPE AM-4.16 MAGNE-BLAST CIRCUIT BREAKER

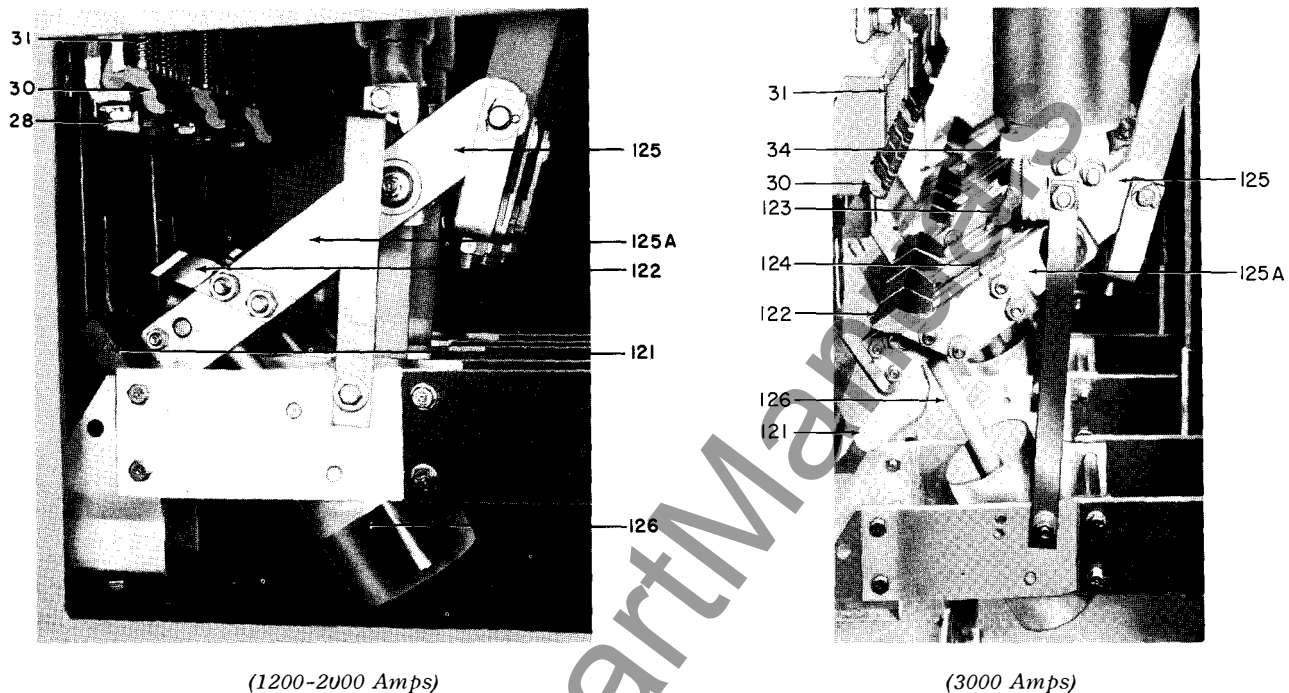

Fig. 4. Contact assembly (Ref. No. 120)

CONTACT ASSEMBLY (REFER TO FIG. 4)

Ref. No.	Catalog Number for Type AM-4.16-350			No. Req'd	Description
	1200 Amp	2000 Amp	3000 Amp		
120	073-213X0343G160	073-213X0343G161	073-132C2748G002	3	Contact assembly
*121	227A5306G001	227A5306G001	227A5306G002	3	Movable arcing contact
122	137A9164P003	137A9164P003	114C5382P011	6	Movable primary contact
122	137A9164P004	137A9164P004	114C5382P012	6	Movable primary contact
123	-----	-----	114C5382P002	12	Tertiary contact finger
124	-----	-----	619C0469P003	6	Movable tertiary contact
125	258C0666P007	258C0666P007	619C0469P004	6	Contact arm
125A	-----	258C0666P006	619C0469P007	6	Contact arm
126	213X0343G094	213X0343G094	132C2748G003	3	Piston assembly

*Not illustrated